

FORMAX[®]

AutoSeal[®]

FD 1506 Plus / FE 1506 Plus

FK / FL SERIES

TABLE OF CONTENTS



DESCRIPTION	1
UNPACKING AND SET-UP	1 - 2
CONTROL PANEL	3
OPERATION	3
FOLD PLATE ADJUSTMENT	4
SETTING CUSTOM FOLDS	5
DETERMINING FOLD TYPE	6
TEST SHEET	7
ERROR SCREENS	8
DAILY MAINTENANCE	9
TROUBLESHOOTING	9 - 11
INSTALLING OPTIONAL FLOW STRAPS	12

DESCRIPTION

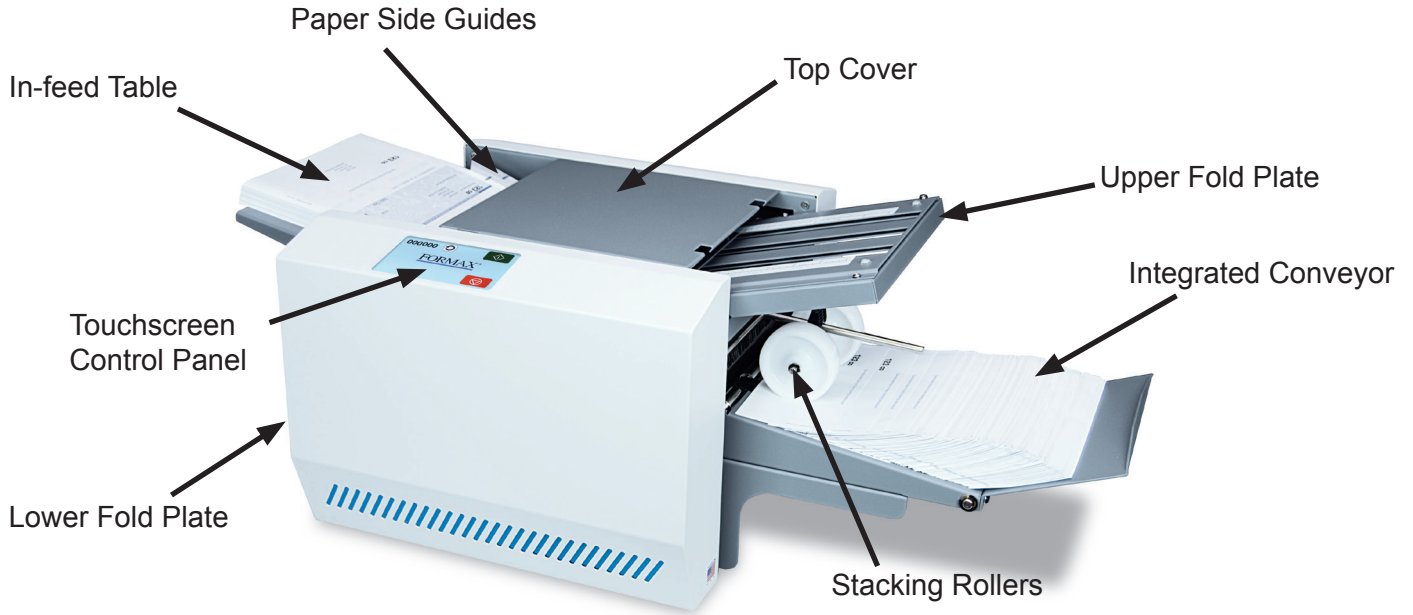

FUNCTION:

The 1506Plus Pressure Sealer folds and seals many different configurations, including “C”, “Z”, “V” and custom folds. It also accommodates several different sizes of forms. For configurations and/or paper sizes specifications below.

Paper size:	Up to 8.5” W x 14” L
Fold styles:	C, Z, V uneven Z, uneven C, custom folds
Fixed speed:	Up to 6,250 sheets per hour
Hopper capacity:	Up to 200 sheets 20#
Weight:	90 lbs.
Dimensions:	37” L x 17” W x 13” H
Power supply:	120V, 50/60 Hz
Certifications:	UL Approved

UNPACKING & SET-UP

1. Check package for shipping damage. If there is shipping damage, do not discard the box.

2. CAUTION: Two people are required to lift the machine out of the box.

3. Place the jam clearing handle into the the holder which is mounted to the machine. This is the jam clearing tool’s proper location (see picture, right).

4. Install upper fold plate (refer to pages 4 and 5 for proper installation).

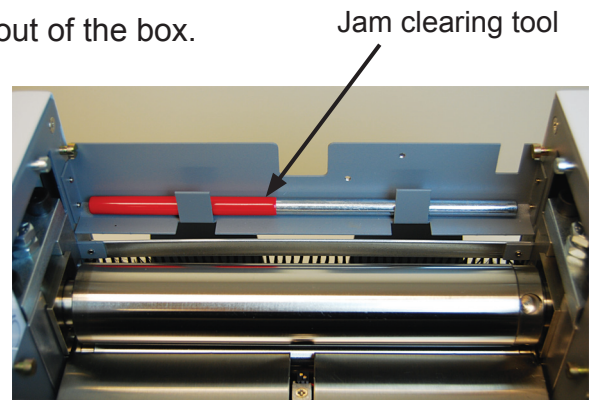

UNPACKING AND SET UP, continued

5. To attach the conveyor to the out-feed, align the tab on the right side of the conveyor with the slot on the machine (Figure 1a). Rest the support braces on the two alignment studs (see arrows), and tighten the four thumbscrews provided (Figure 1b).

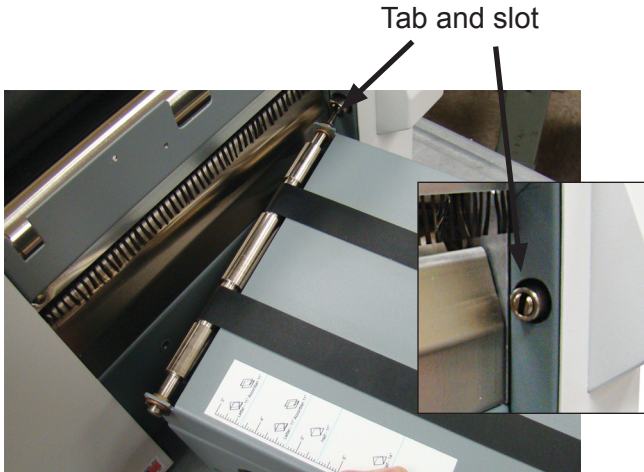

Figure 1a

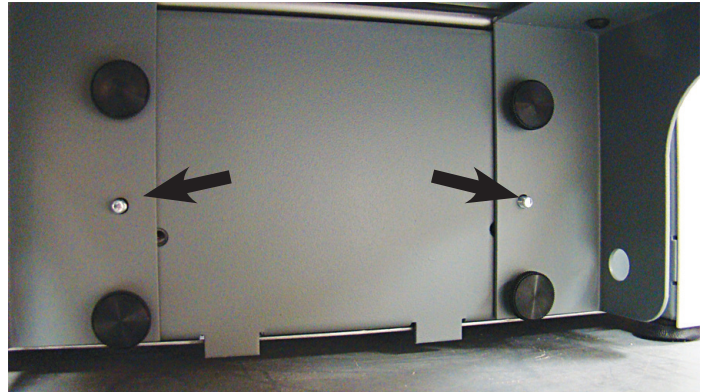

Figure 1b

3. Install outfeed wheels (Fig. 1c) by inserting the right side (spring loaded) into the right side of the body, just above the conveyor (Fig 1d), then insert the left end of the outfeed wheel crossbar into the left side.

4. Plug cord into machine and into wall outlet.

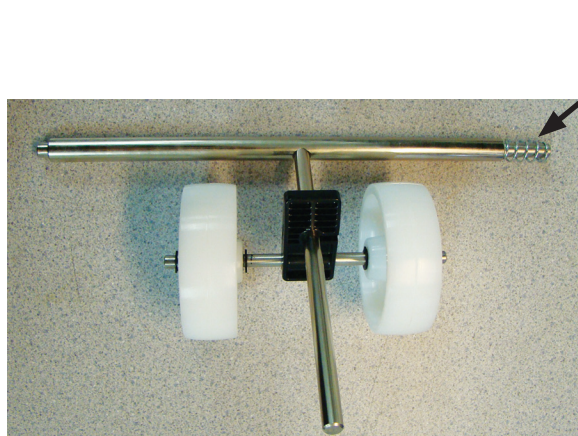

Figure 1c

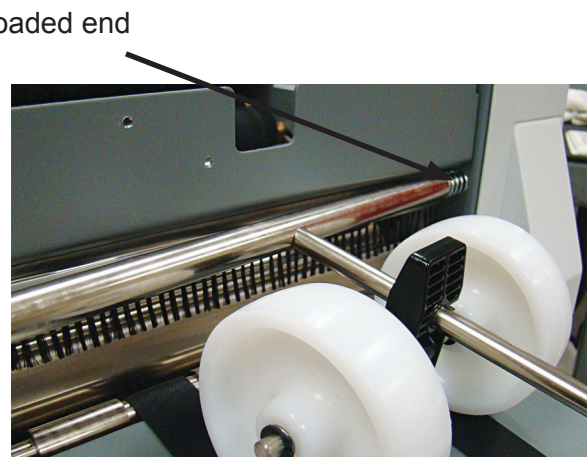
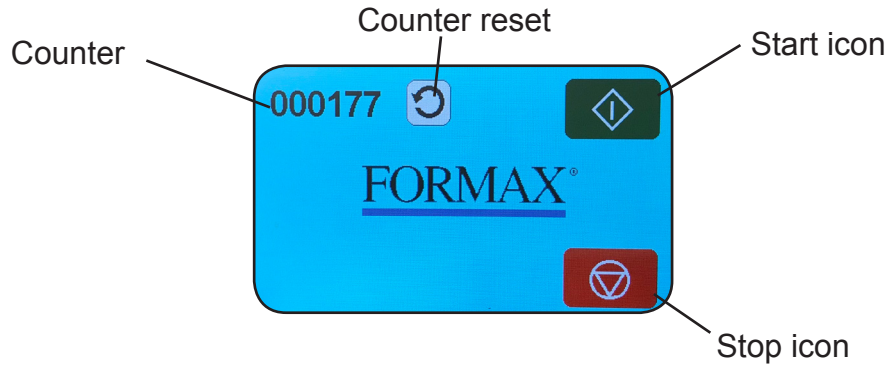

Figure 1d

CONTROL PANEL



OPERATION

1. Adjust fold plates to desired fold for length of paper (see fold plate adjustment on page 4). To do this, loosen the two thumbscrews (Figure 4a & b) on each fold plate. Align center bar (Figure 4a & b) so the marks on each side match up. For “V” folds, remove the lower fold plate, turn around 180° and reinstall.
2. Make sure fold plates and cover are reinstalled properly.
3. Plug in cord and turn power on (Figure 2).
4. To make sure folds are in the correct location, push the paper feed lever (Figure 3) down and place one form onto the in-feed table and press the start button. Adjust fold plates if necessary (see fold plate adjustment on page 4).
5. Push the paper feed lever down and load paper neatly stacked and squared onto the in-feed table. Paper can be stacked up to 200 sheets. **Note:** Standard “Z” fold forms can be loaded face up or down with the glue edge leading. All “C” fold forms must be loaded face up with glue edge leading.
6. Press the start button to begin operation.



Figure 2

Power Switch

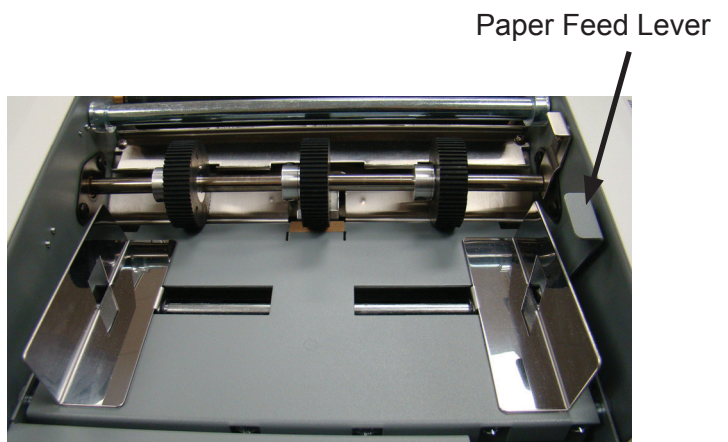
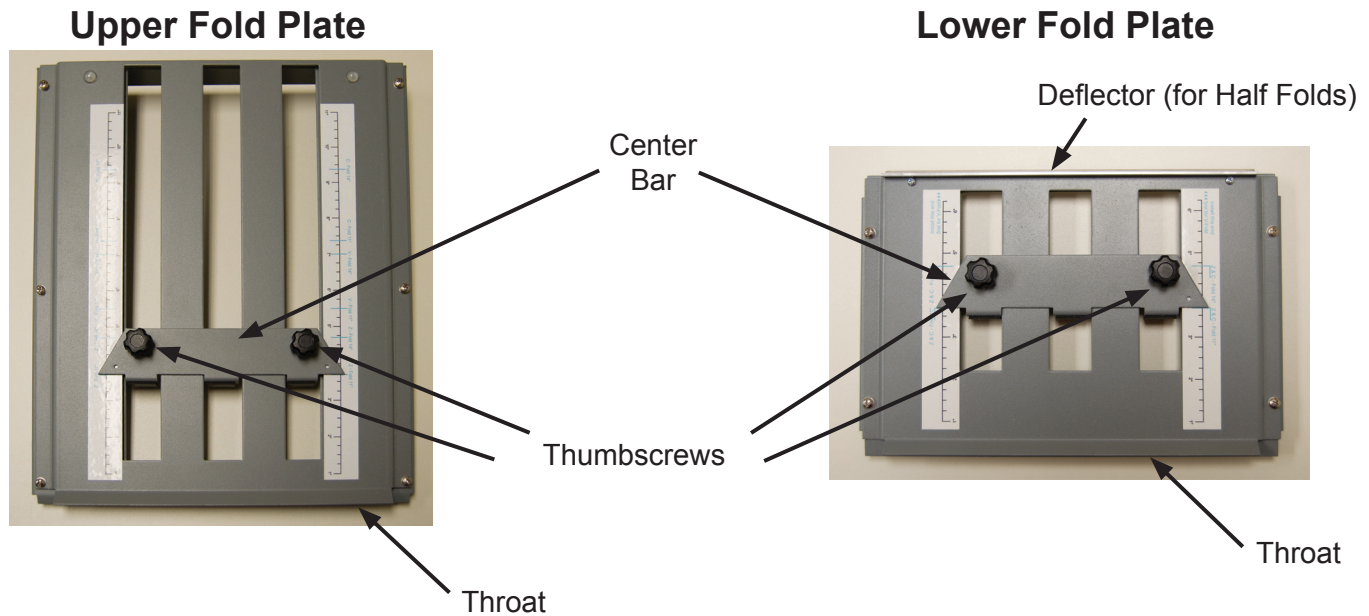

Figure 3

FOLD PLATE ADJUSTMENT



1. To adjust the first fold remove the top cover to access the top fold plate. If the first fold is too long loosen the two thumbscrews on the upper fold plate and slide the bar down. If the fold is too short loosen the thumbscrews and slide the bar up.

NOTE: The bar should be on the same marks on each side.

2. To adjust the second fold remove the lower fold plate. If the second fold is too long loosen the two thumbscrews and slide the bar up. If the fold is too short loosen the thumbscrews and slide the bar down.

NOTE: The bar should be on the same marks on each side.

3. For quick setup of "C", "Z", Uneven "C" and "V" folds refer to the blue lines on the fold plate.

4. To reinstall the upper fold plate, slide the plate (with thumbscrews facing up and the throat toward the inside of the machine) until the grooves on the underside line up with the four pins on the machine (Figure 4a & 4b).

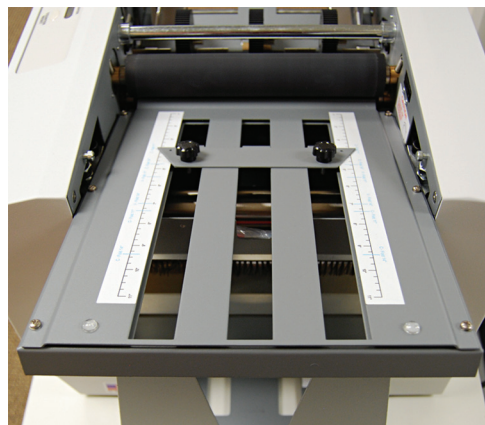
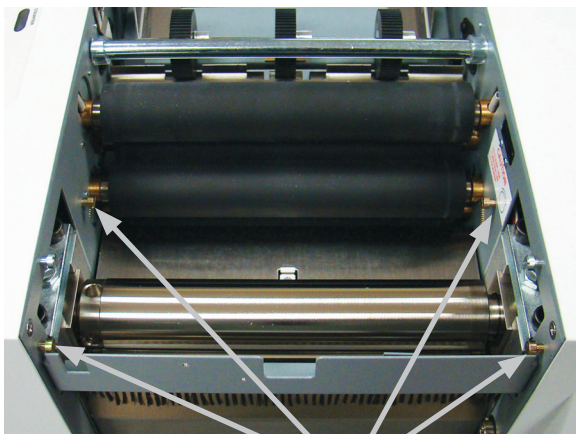

Figure 4a

Fold Plate Pins

Figure 4b, correctly installed

5. To reinstall the lower fold plate, slide the plate (with the thumbscrews facing up and throat toward inside of machine, figure 5b) until it rests on the two silver bars (figure 5a) and locks into place (figure 5c).

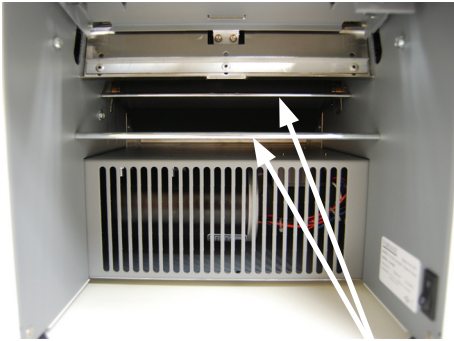

Figure 5a

Bars

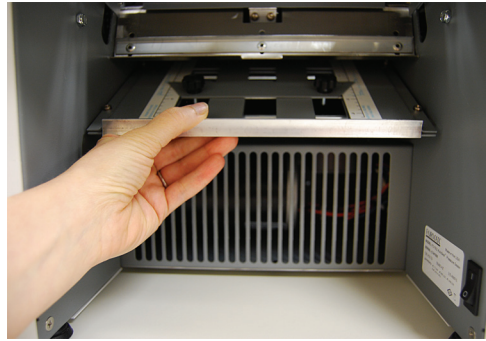

Figure 5b

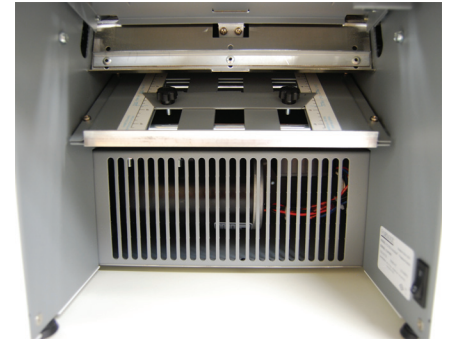
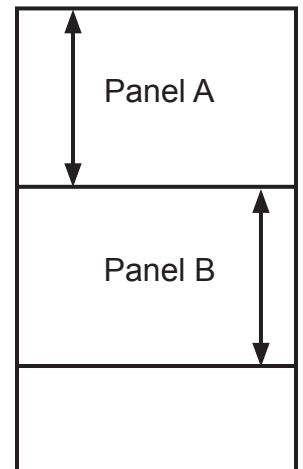

Figure 5c

SETTING CUSTOM FOLDS

Eccentric “Z”

1. Measure the length of panel “A”.
2. Adjust the upper fold plate so that the bar lines up with the measurements of panel “A”, for example: if panel “A” is 5 1/4” long move the bar up or down so that it lines up with the 5 1/4” mark on the fold plate.
3. Measure the length of panel “B”.
4. Adjust the lower fold plate so that the bar lines up with the measurements of panel “B”.
5. Load forms and press start (refer to OPERATION on page 2).



Uneven “C” / Return Mailer

1. Measure the length of panel “A” & “B”.
2. Adjust the upper fold plate so that the bar lines up with the measurements of panel “A” & “B”, for example: if panel “A” + “B” is 10 1/2” long move the bar up or down so that it lines up with the 10 1/2” mark on the fold plate.
3. Measure the length of panel “B”.
4. Adjust the lower fold plate so that the bar lines up with the measurements of panel “B”.
5. Load forms and press start (refer to OPERATION on page 2).

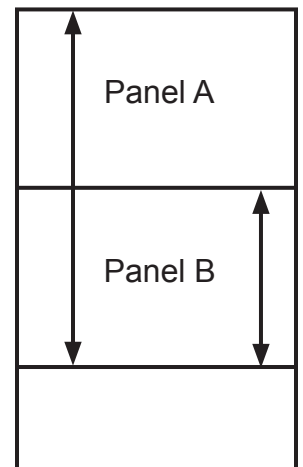

DETERMINING FOLD TYPE

Two Standard Folds 11" "Z" & 11" "C"
Refer to page 5 for custom fold setup.

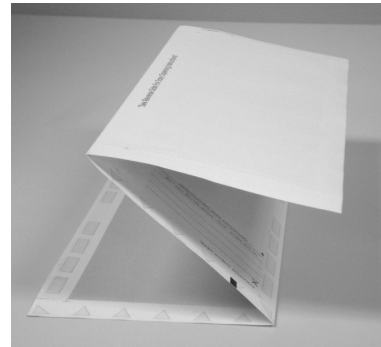
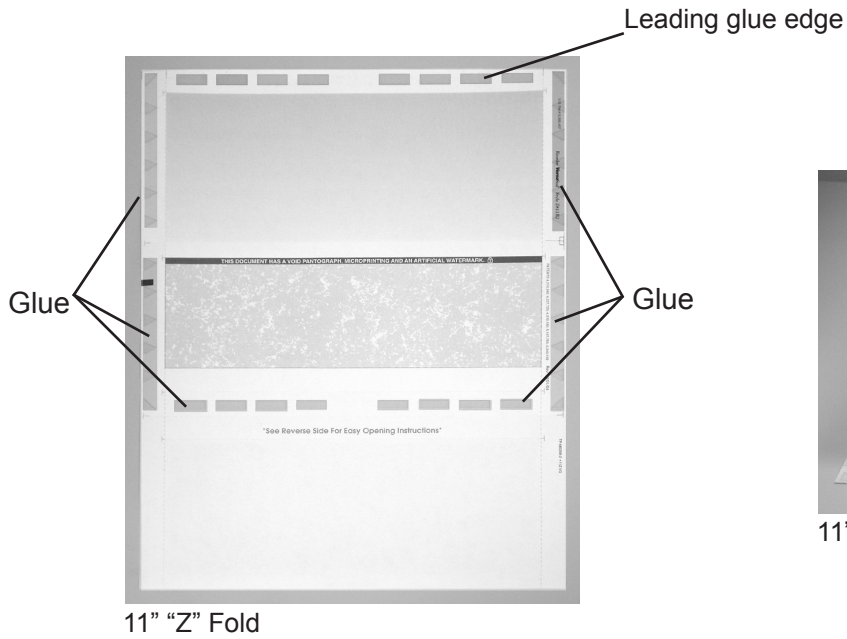

11" "Z" Fold

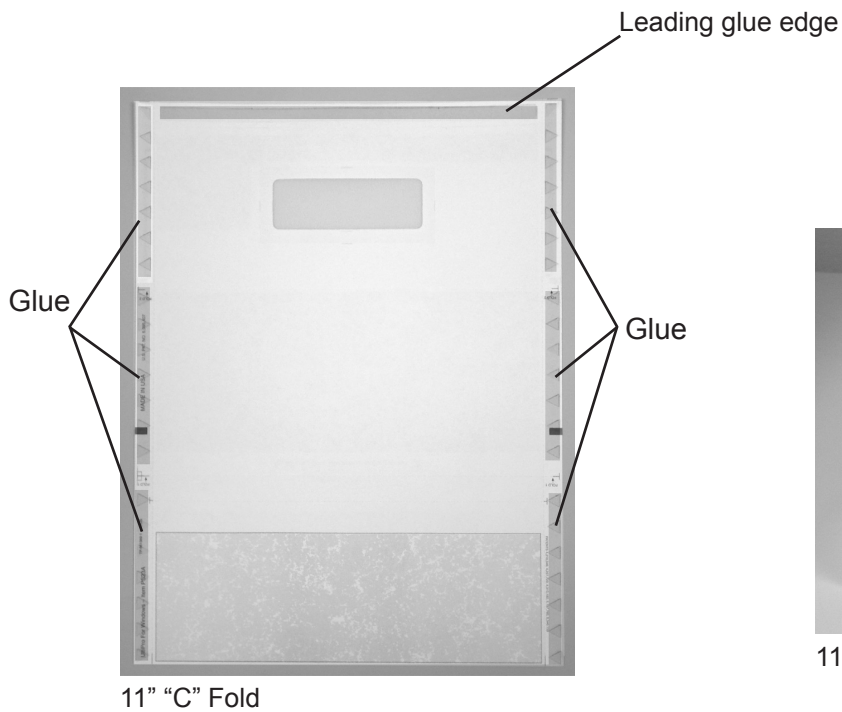

11" "C" Fold

Leading Edge



Make copies of this page on copy paper for fine tuning folds

Instruction For Lining Up Folds

1. Place a stack of these sheets into the feeder and fold one (1) or two (2) sheets.

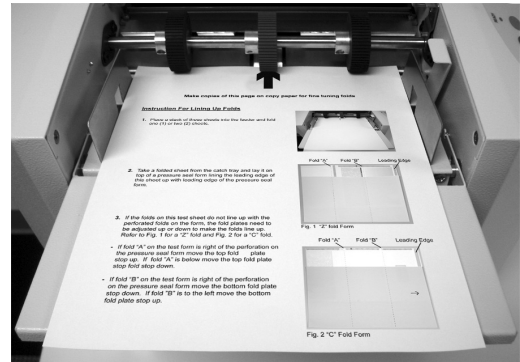

2. Take a folded sheet from the catch tray and lay it on top of a pressure seal form lining the leading edge of this sheet up with leading edge of the pressure seal form.

Fold "A" Fold "B" Leading Edge

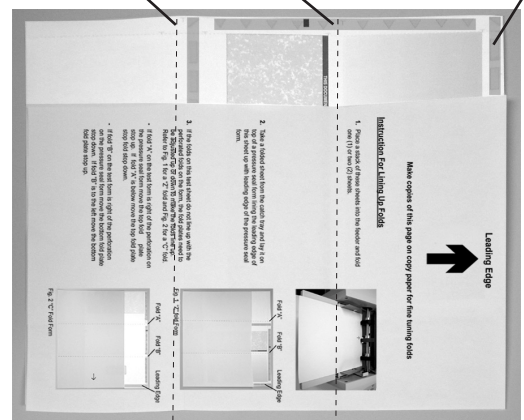

3. If the folds on this test sheet do not line up with the perforated folds on the form, the fold plates need to be adjusted up or down to make the folds line up. Refer to Fig. 6 for a "Z" fold and Fig. 7 for a "C" fold.

- If fold "A" on the test form is right of the perforation on the pressure seal form move the top fold plate stop up. If fold "A" is below move the top fold plate stop fold stop down.
- If fold "B" on the test form is right of the perforation on the pressure seal form move the bottom fold plate stop down. If fold "B" is to the left move the bottom fold plate stop up.

Fold "A" Fold "B" Leading Edge

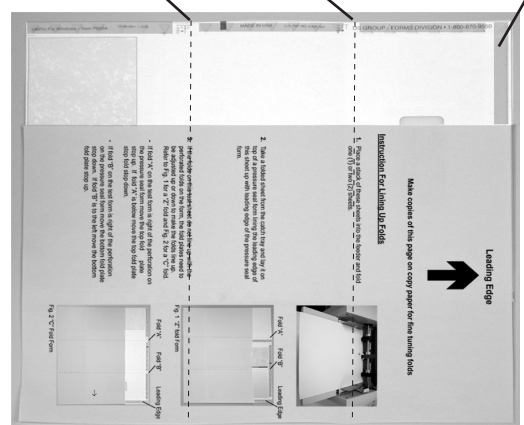
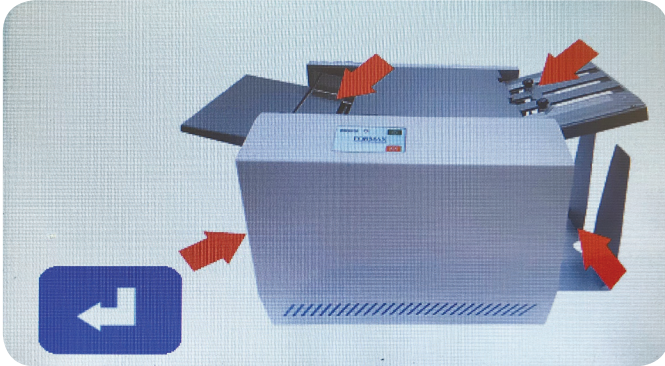



Fig. 7 "C" Fold Form

ERROR SCREENS

Paper Out / Paper Mis-Feed / Paper Jam



1. The feeder is empty. Load paper into the feeder and press the “” icon to resume operation.

2. A mis-feed has occurred. Reset the stack of paper in the in-feed and press the “” icon to resume operation.

3. A Paper jam has occurred in one of the areas indicated. Turn the folder to the off position and unplug. Check the area indicated for paper and remove. Replace the fold plates and plug the folder in and the power on.

Cover Open



The top cover is open. Close the top cover and press the “” icon to resume operation.

DAILY MAINTENANCE

1. It is recommended to let forms cool for one-half hour, from the laser printer, before folding and sealing. This allows toner to set on the forms, and static electricity to discharge. The FD400 Jogger is recommended for best results. The Jogger squares the forms and dissipates heat and static created by laser printers.
2. If toner builds up on the metal sealer rollers, clean the rollers with a lint-free cloth dampened sparingly with a mild household cleaner.
3. Clean in-feed wheels and fold rollers with Formax-recommended roller cleaner & rejuvenator to remove paper dust and toner. A damp cloth with water is the best alternative. **CAUTION:** Do not use any chemicals other than the roller cleaner & rejuvenator or water.

TROUBLESHOOTING

A. Clearing paper jams:

WARNING: Turn machine off and unplug cord from its receptacle.

1. If a jam occurs in between the metal sealing rollers, remove any remaining forms from the hopper. Remove the top cover and the upper fold plate. Remove the jam-clearing tool (located under top fold plate), apply the tool to the upper metal roller (Figure 8) and turn clockwise (**Caution:** Do not apply excessive force or rollers may be damaged) until the paper jam is clear. Remove the jammed form and return tool in holder and reinstall the upper fold plate. Reinstall cover and press the start button.

Note: Press the black button (Figure 9) near the power cord inlet to reset the breaker if necessary.

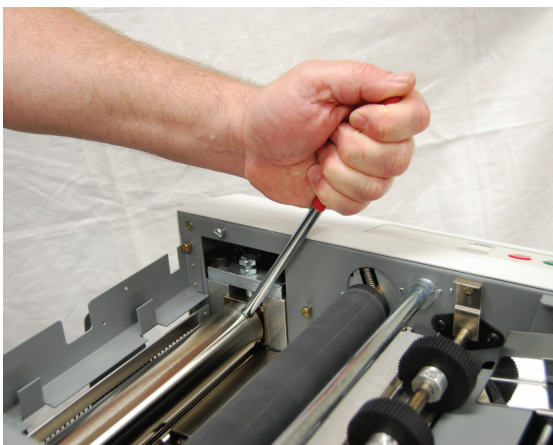

Figure 8



Figure 9

2. If a jam occurs in the fold plates, remove fold plate and remove paper. Reinstall fold plate.

TROUBLESHOOTING

B. Fold quality needs improving:

1. Make sure paper is squared and installed correctly. Side guides should be evenly balanced and snug against the paper.

B1. If folds are still incorrect, adjust fold.

1. Take a piece of plain copy paper and mark the leading edge (first edge of paper to feed into machine).
2. Run the paper through the machine.
3. Place a pressure seal form on the top cover of machine.
4. Place the piece of plain paper, just processed, on top of the pressure seal form, aligning the leading edge of both forms (see diagram below).
5. Check to see if folds on the plain paper line up with the fold perforations of the pressure seal form (see Figure 10 below). If the folds on the plain paper & fold perforations on the pressure seal forms do not line up, adjust the fold plates (see fold plate adjustment on pg. 4).
6. Once the adjustments have been made, take one pressure seal form and test it.
7. Tear open processed form and inspect to see if they line up with the fold perforations.

NOTE: Repeat the above process until the folds on plain paper line up with the perforations on the pressure seal form.

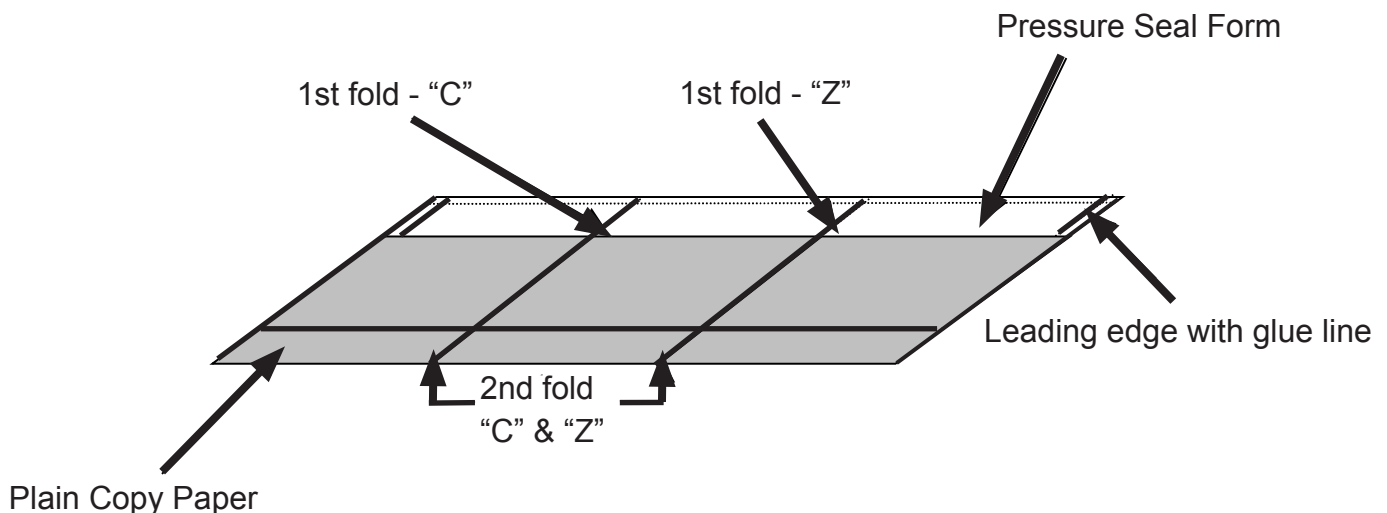

Figure 10

TROUBLESHOOTING

C. Paper is not folding square (Skewing):



Figure 11

1. If paper pulls left or right adjust the skew. Turn the skew adjuster, located under the infeed tray, (Fig. 11) left or right until the paper is feeding correctly.

D. Machine plugged in, no power

1. Turn machine ON.
2. Make sure top cover is installed properly.
3. Press the circuit breaker (Figure 9).
4. Check wall outlet.
5. Remove operator cover check the fuse located on control board next to transformer.
6. Check all electrical connections.

E. Double feeding / Mis-feeding

1. Clean feed wheel, using soap and water.
 - a. Check center in-feed roller and singulator pad for wear. Replace pad if it is cupped.
 - b. Check to see if center in-feed roller is centered on the gate tip.
2. Run a stack of plain paper. This is done to check on proper feeding. If double-feeding does not occur on the paper:
 - a. Check to be sure pressure seal forms are not sticking together. Jogging or hand separating may be necessary to determine this.
 - b. Hand separate about 50 forms, align and test-run the forms. If no double feeding occurs, proper forms handling is necessary.

INSTALLING OPTIONAL FLOW STRAPS

1. Optional Flow Straps can be used when processing thicker paper stock. To install, fold over 1/2 inch of strap. (Figure 12a & b)

2. Place strap over static brush in appropriate location. (Figure 13)

NOTE: Straps should not be placed where they will interfere with the conveyor belts or the weighted out-feed tires, (see Figure 14).

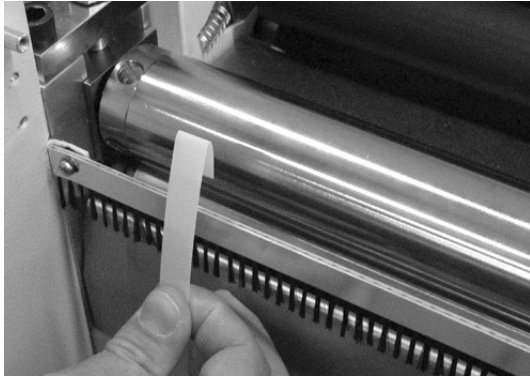

Figure 12a

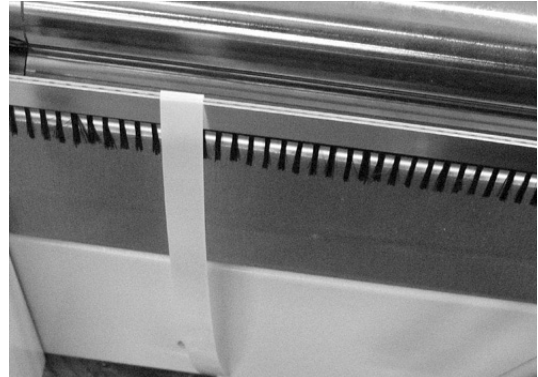

Figure 12b

3. With strap in place, press clip down over strap. (Figure 13)

4. Figure 14 shows strap and clip in place.

NOTE: Clip must be removed before moving strap to a different location.

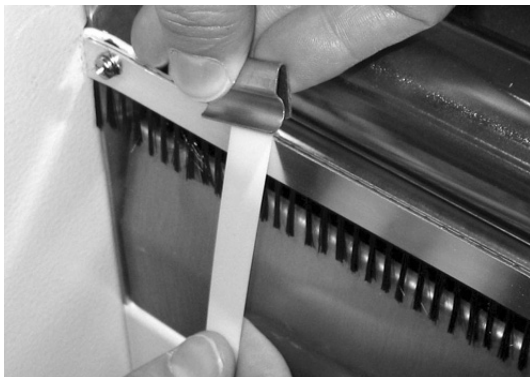

Figure 13

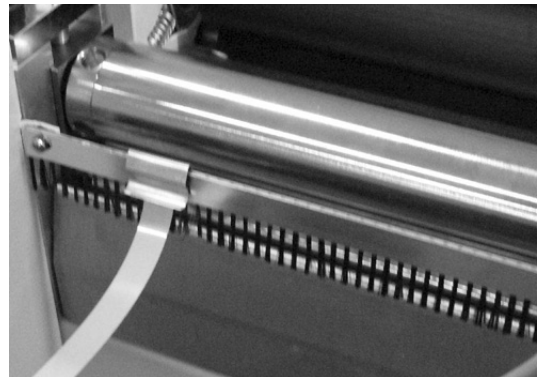

Figure 14

5. Repeat process on other side. Figure 15 shows two straps in place.

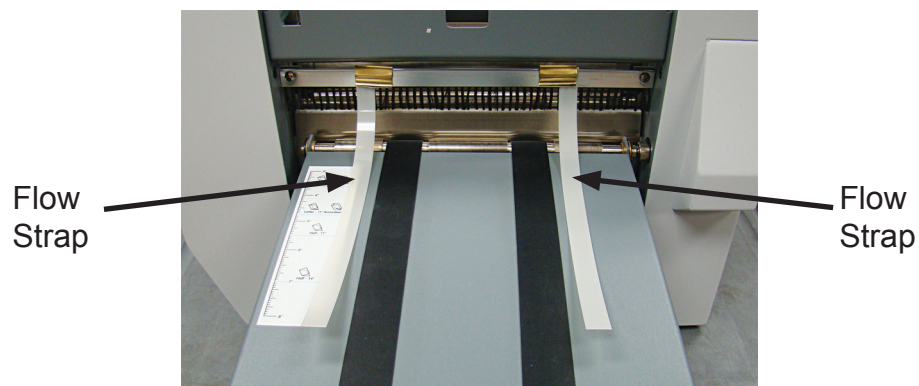

Figure 15