

FORMAX[®]

FD 574
Tabletop Cut-Sheet Cutter

Notes on Safety (Please Read and Observe)

Safety Precautions

Warning Terminology

The following warning terminology is used in this installation manual.

WARNING

Indicates a high degree of potential danger. If the warning is ignored, death or serious injury may result.

CAUTION

Indicates a medium degree of potential danger. If the caution is ignored, medium injury or damaged to property may result.

<Examples of Pictorial Symbols>









- A circle with a line through it indicates a prohibited action. The particular act prohibited is indicated by a picture inside the circle. (In the example shown here, the prohibited act is disassembly.)



- A black disc indicates an instruction, or sometimes a prohibited action. The instruction itself is indicated by pictorial symbols drawn in white on the disc. (In the example shown here, the instruction is 'Remove the plug from the outlet'.)

- The precautions below are vital for safety and must be taken.

 WARNING	
	<ul style="list-style-type: none">● Use only the power cord that is provided among the accessories. Insert the power cord plug firmly into the socket, so that proper electrical contact is effected. → Use of any other power cord could result in imperfect grounding. If grounding is imperfect and electrical leakage occurs, fire or electric shock could result.
	<ul style="list-style-type: none">● Do not use a source voltage other than that specified. Do not connect two or more loads to a single outlet. → Doing so may result in fire or electric shock.
	<ul style="list-style-type: none">● Do not place the machine in a humid or dusty area. → Doing so may result in fire or electric shock.

 CAUTION	
	<ul style="list-style-type: none">● Do not place the machine in an unstable position, such as on an unsteady support or sloping area. → If the machine is dropped or falls over, this could result in personal injury.
	<ul style="list-style-type: none">● Once the machine is placed on the optional cabinet, secure the cabinet using the casters. → If the machine falls over, this could result in personal injury.

1. Unpacking checks

1. Check the product name on the package.
Product name : Cut Sheet Cutter FD 574

2. Unpack the package.

IMPORTANT Carry out unpacking in a place that is safe for the work .

3. Check the packaged items below.

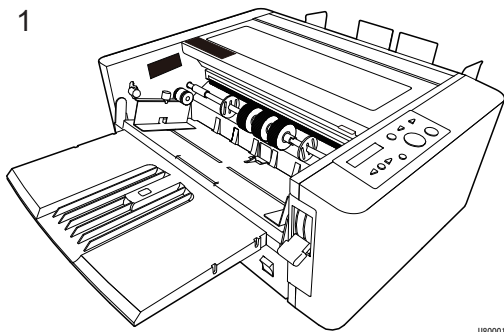

U80001

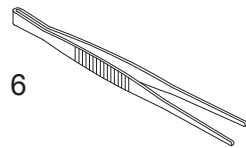
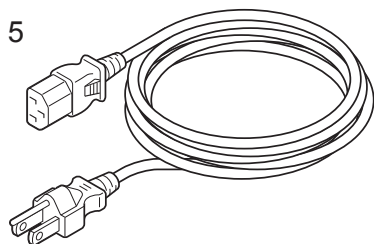
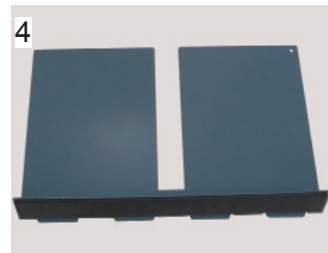
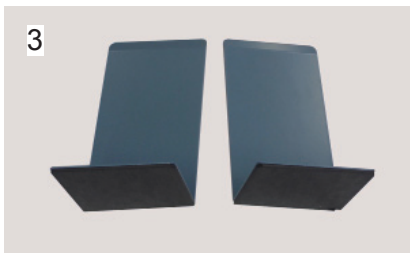

U80502

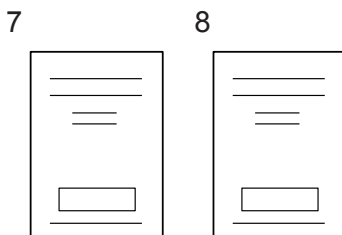

U80503

No.	Part Name	Qty.
1	Cut Sheet Cutter FD 574	1
2	Stacker	1
3	Ejection guide	2
4	Paper stopper	1
5	Power cord	1
6	Tweezers	1
7	Instruction manual	1
8	Installation manual	1

2. Installation Procedure

1. Place the main unit in the location to be installed and remove the tapes.
Remove the protection paper from the paper feed rings.

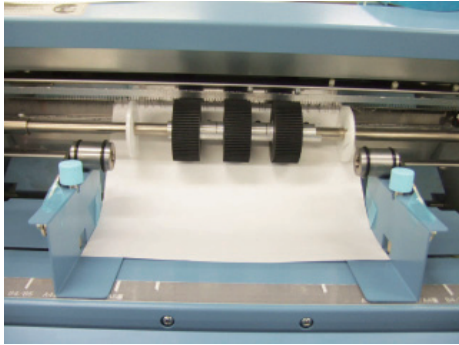

2. Hook the key-shaped holes in the stacker onto the Z collars on the main unit, and slide the stacker downward.

NOTE

Make sure that the stacker is set in place.

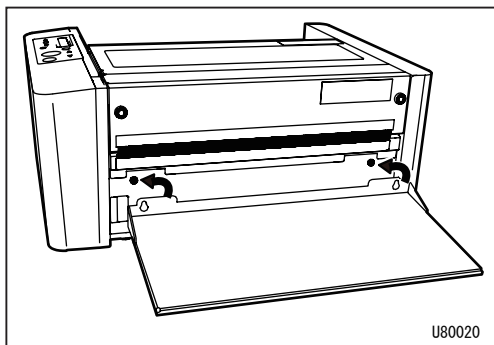

3. Attach the ejection guides and the paper stopper on the stacker.

NOTE

Adjust each position according to the finished paper size.

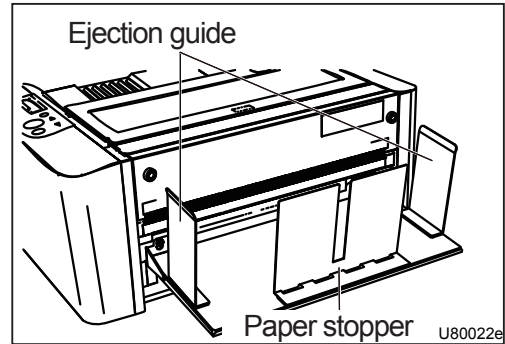

3. Turning the power ON

1. Confirm that the power switch is turned off.

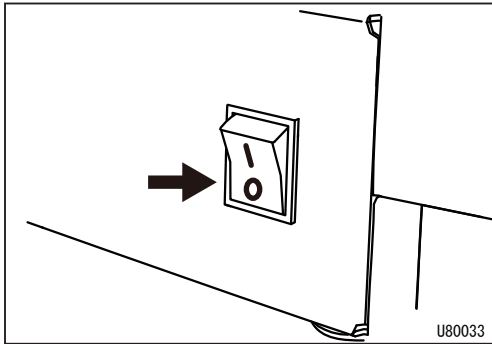

2. Securely connect the female plug of the power cord that came with the FD 574 to the inlet.

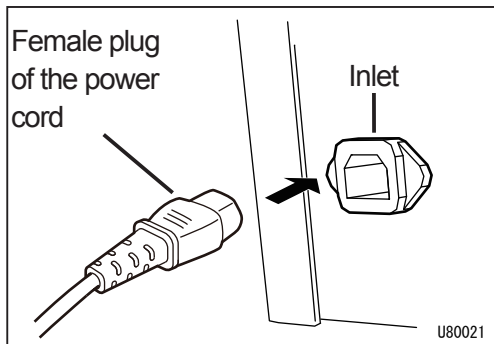

3. Insert the male plug of the power cord into the outlet (three-slot).

WARNING

- Insert the power cord plug firmly into the socket, so that proper electrical contact is effected. If grounding is imperfect and electrical leakage occurs, fire or electric shock could result.

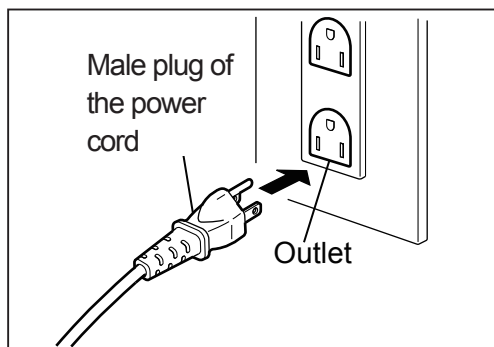

NOTE

When installing an optional unit, complete the main unit installation and make sure that the machine operates normally before installation. Refer to the Installation Manual of each optional unit for installation.

4. Confirm that the plugs in steps 2 and 3 are securely inserted.

WARNING

- Connect the machine to an outlet providing a 60Hz, 15A power supply of at least 120V.
- Insert the power cord's plug correctly into the outlet, so that electrical connection is effected completely.
- Position the machine close to the power outlet. Do not connect multiple loads to a single outlet. If an extension cord is necessary: Extension cord should be of at least 130V, 15A specification, conforming to standard, and not exceed 5 m in length.
- The power cord should never be stepped on, or crushed between objects. If it is, accidents could result.

5. Turn on the power switch.

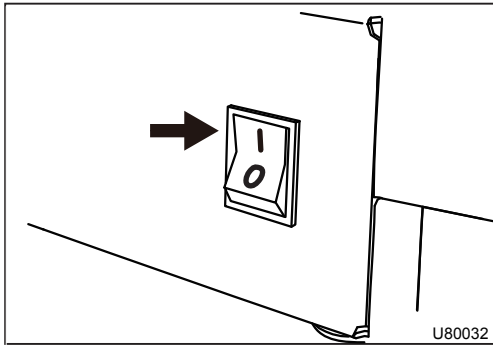

6. Check the LCD on the control panel.
- The control panel must display normally.