

FORMAX[®]

FD 340

Document Folder

OPERATOR MANUAL
SECOND EDITION

TABLE OF CONTENTS

SUBJECT	PAGE
DESCRIPTION	1
SPECIFICATIONS	1
UNPACKING	1
SETUP	2
CONTROL PANEL	2
OPERATION	3
SETTING CUSTOM FOLDS	4
BATCH COUNTING	4
MULTI-SHEET FEEDER (OPTIONAL)	5
CROSS FOLDING	6
STACKER WHEEL POSITIONING GUIDE	6
STACKER WHEEL SETUP FOR THICK PAPER	7
OPERATOR MAINTENANCE	8
TROUBLE-SHOOTING	9







DESCRIPTION



FUNCTION

The FD 340 Folder is designed to perform a wide variety of folds using a variety of paper weights. The fold plates are manually adjusted for standard folds and custom folds. Batch counting, self-centering side guides, and the capability to cross-fold are added features. The folder will automatically stop after the last document has been folded.

SPECIFICATIONS

Paper size:	3.5" X 5" TO 11" X 17" (88.9 W x 127 L TO 311W x 432 L mm)
Fold types:	Letter  , Zig-Zag  , Single  , Gate  , Fold Out  , Double Parallel  and Custom Folds
Feed table capacity:	Up to 500 sheets of 20# paper
Processing speed:	Up to 12,000/hour, depending on fold type.
Power requirements:	FD Model: 120 volts A.C., 50/60 Hz, 2.5 amps. FE Model: 240 volts A.C., 50/60 Hz, 2 amps
Dimensions during use:	Closed: 33" L x 20" W x 19" H (84 L x 51 W x 48 H cm) Fully Extended: 60"L x 20" W x 19" H (152 L x 51 W x 48 H cm)
Weight:	67 lbs (30.39 kg)

UNPACKING

1. Check package for shipping damage. If there is shipping damage, do not discard the box.
2. Remove the machine and packed components from the box. The fold plates, telescoping stacker, power cord and cross-fold guide are wrapped separately in the box.

NOTE: Two people must lift the machine from the box.

3. Place the machine on a solid stand.
4. Attach telescoping outfeed stacker.

SETUP

1. Install upper and lower fold plates in position. Be sure the plates are set firmly on the locating pins (Fig 1a & 1b). Slide the fold plate in until it meets the first locating pin then push down to lock it in position (Fig. 2).
2. Make sure the power switch is in the "OFF" position.
3. Plug the power cord into the power inlet and the wall outlet.

Lower Fold Plate Pins

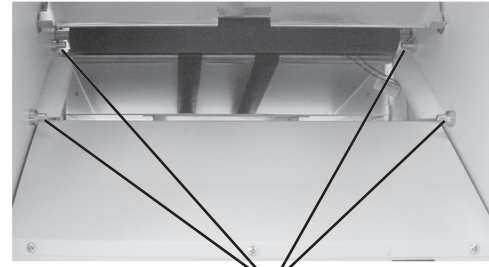

Fig. 1b Locating Pins

Upper Fold Plate Pins

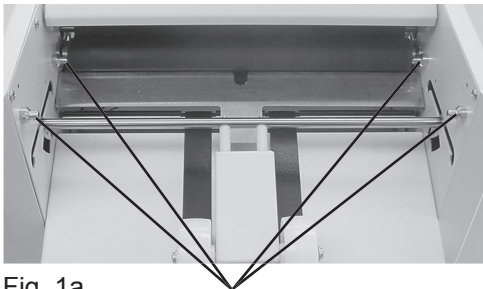

Fig. 1a Locating Pins

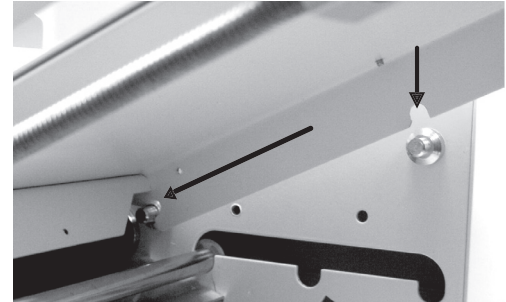
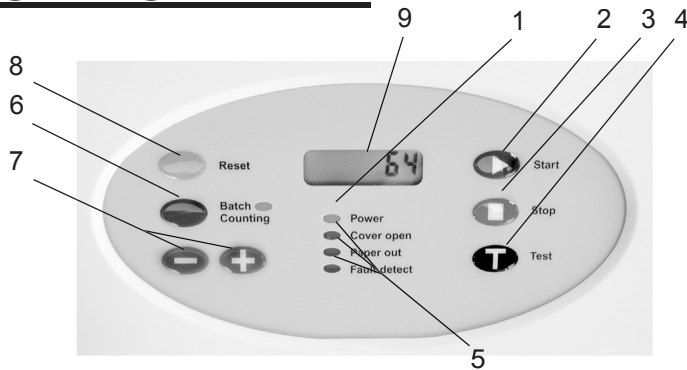

Fig. 2

CONTROL PANEL



No.	NAME	FUNCTION
1	Power Indicator	Lights up when power is on.
2	Start Button	Press to run the machine. Will not operate if a red fault light is on.
3	Stop Button	Press to stop the machine.
4	Test Button	Test folds two documents.
5	Fault Indicator Lights	Stops the operation and indicates the problem area. Turn off the light by closing cover, and/or placing paper on the in-feed tray. Press the "Reset" button to turn off the "Fault detect" light.
6	Batch Counting Button	Select the batch counting function.
7	"-" and "+" buttons	Select the number of documents to be folded.
8	Reset Button	Resets the fault detect circuit and the counter. CAUTION: when a fault happens and light is lit, only press the button one time. If you press it a second time, you will reset the counter.
9	Counter Display	Shows the number of documents processed. When power is turned on it displays "F-01".

OPERATION

1. Place power switch in the “ON” position.
2. To set the fold plate stop position, squeeze the stop plate lever and move the stop plate to the desired location on the upper and lower fold plates (Fig 3). Align the pointed part of the stop plate with the desired marks on the decal and release the lever. Fine adjustments can be made with the adjustment knob at the end of the plate (Fig 4).

NOTE: When doing a “Single” fold, be sure to move the lower fold plate stop all the way to the front of the plate. The plate must be firmly reinstalled on the locating pins.

3. Extend the catch tray as required.
4. Move the stacker wheels to the proper position for the paper size (Fig 5) (Refer to chart on page 6).
5. Lift the in-feed tray extension into position.
6. Raise the in-feed tray lever.
7. Set the paper side guides for the paper you’re using and lock in position.
8. Neatly stack paper on the in-feed tray.
9. Lower the in-feed tray lever.
10. Press the “Test” button on the control panel to check the folds. Adjust as needed.
11. If the fold is skewed use the skew adjustment knob to make corrections (Fig. 6).
12. When you’re satisfied with the test folds, press the “Start” button to operate the machine.

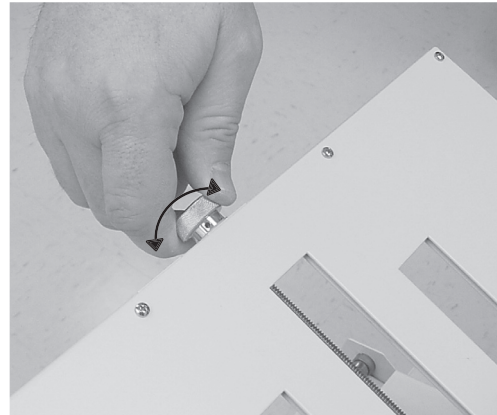

Fig. 4

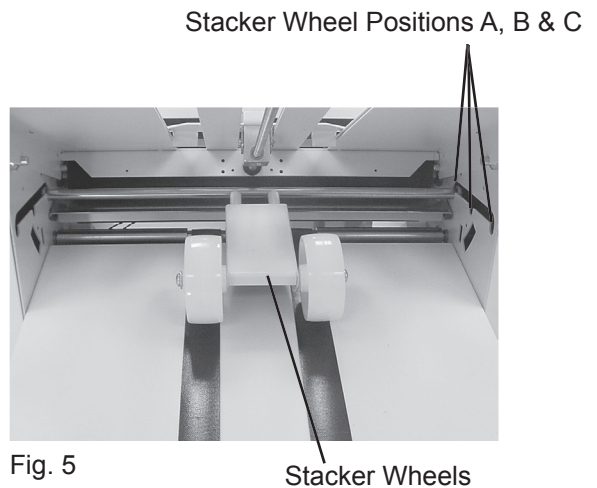

Fig. 5

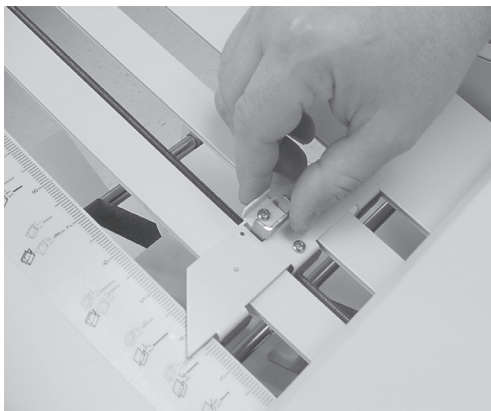

Fig. 3

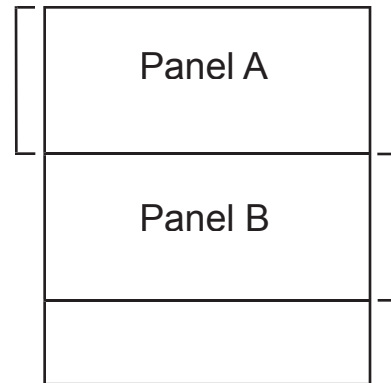

Fig. 6

SETTING CUSTOM FOLDS

Example 1: Uneven “Z”

1. Measure the length of panel “A”
2. Adjust the upper fold plate so that the stop plate lines up with the measurements of the panel “A” i.e. if panel “A” is 5.25” long slide the stop plate up or down so that it lines up with the 5.25” mark on the fold plate.
3. Measure the length of panel “B”
4. Adjust the lower fold plate so that the stop plate lines up with the measurement of panel “B”
5. Load forms and press test. If folds are too long or too short adjust accordingly.



Example 2: Uneven “C”

1. Measure the length of panel “A” & “B”
2. Adjust the upper fold plate so that the stop plate lines up with the measurements of panel “A” & “B”. i.e. if panel “A” & “B” are 10” long slide the stop plate up or down so that it lines up with the 10” mark on the fold plate.
3. Measure the length of panel “B”
4. Adjust the lower fold plate so that the stop plate lines up with the measurement of panel “B”
5. Load forms and press test. If folds are too long or too short adjust accordingly.

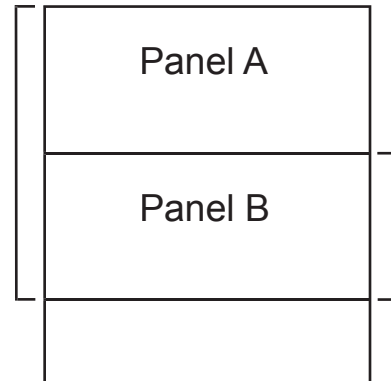

BATCH COUNTING

The batch counter can be set from “0” to “999”. Press the “Batch Counting” button to illuminate the “Batch Counting” light. Press the “-” or “+” buttons to select the number of documents to be folded. Press the “Start” button. When the counter gets to “0” the machine will stop.

NOTE: The batch counting program will remain on after turning the power off. You *must* press the Batch Counting button to turn off the light and cancel the batch count setting.

MULTI-SHEET FEEDING (OPTIONAL)

The multi-sheet feeder is designed to fold pre-collated stapled or unstapled sets of paper of up to three 20 lb sheets of paper.

1. Make sure that all paper is removed from the feed table.
2. Adjust the side guides on the feeder for the proper paper size. Loosen the brass thumb screw, open or close the guides to fit the paper width and retighten the thumbscrew (Fig 8a).
3. Slide the pre-collated paper set into the multi-sheet feeder. When feeding stapled sets the documents should be placed with the staple on the operators side and leading (Fig 9).
4. The sheets of paper will be automatically pulled into the folder (there is a one second delay after the paper is placed in the feeder).
5. If the fold is skewed, turn the skew adjustment knob located on the back of the feeder left or right to make corrections (Fig 8b).
6. To remove the multi-sheet feeder depress the release levers located on either side of the lower back side of the feeder (Fig. 10), tilt the feeder forward and lift. To reinstall depress the levers and reinsert.



Fig. 8a

Brass thumbscrew

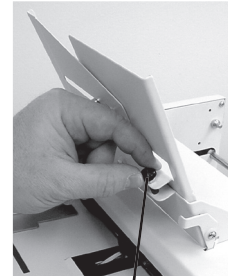

Fig 8b

Skew Adjuster

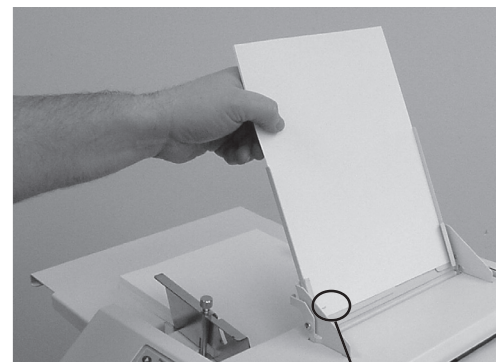

Fig. 9

Staple

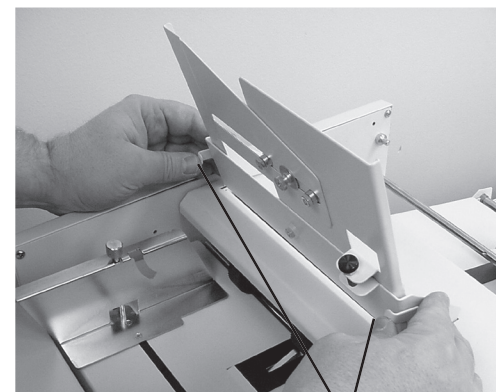

Fig. 10

Release Levers

CROSS FOLDING

Cross folding refers to folding a document in one pass and then running it through the folder a second time to be folded again.

Common Application: Folding an 11" x 17" document in half and then letter folding it to fit in a standard #10 envelope.

1. Load folded paper into the feed tray with the fold crease facing the non-operator side of the folder (Fig 11).

Note: For best results firmly run your hand over the fold crease to help flatten the paper before loading.

2. Attach the cross fold paper guide onto the feed tray paper guide (Fig. 12) and lower guide.

Note: Cross folding ability will vary based on the paper weight and type. If the paper is too heavy it may not be able to be cross folded.

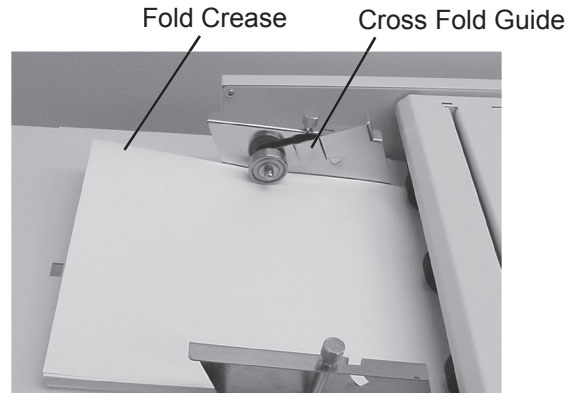

Fig. 11

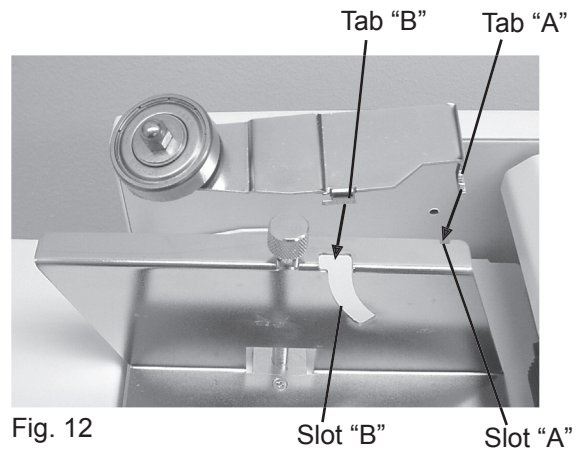

Fig. 12

To install cross fold guide hook tab "A" into slot "A" and then lower tab "B" into slot "B"

STACKER WHEEL POSITIONING GUIDE

Move the stacker wheels to the proper position indicated on the chart based on the fold and paper size. For paper between 28# and 65#* refer to the "Stacker Wheel Setup For Thick Paper" on Pg. 7.

	8.5" x 11"	8.5" x 14"	11" x 17"
Letter	A	A or B	B
Zig-Zag	A	A or B	B
Single	B	B	C
Gate	A	B	C
Fold Out	B	C	C
Double II	A	A	A or B

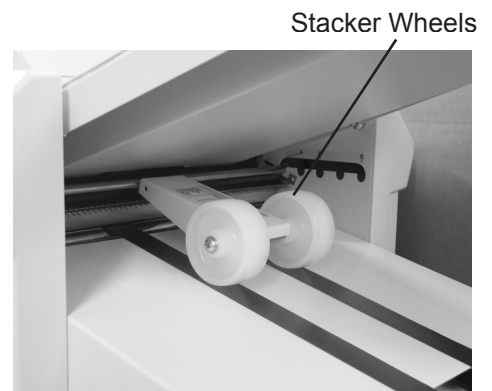

STACKER WHEEL SETUP FOR THICK PAPER

Thicker paper from 28 # up to 65 # may require special stacker wheel setup moving the stacker wheels closer than the position "A" slot.

If stacking is inconsistent move the stacker wheels from the standard position #1 (Fig. 13) to the thick paper weight position #2 (Fig. 14) as indicated in the pictures below. Position # 2 may also be good for small folded documents.

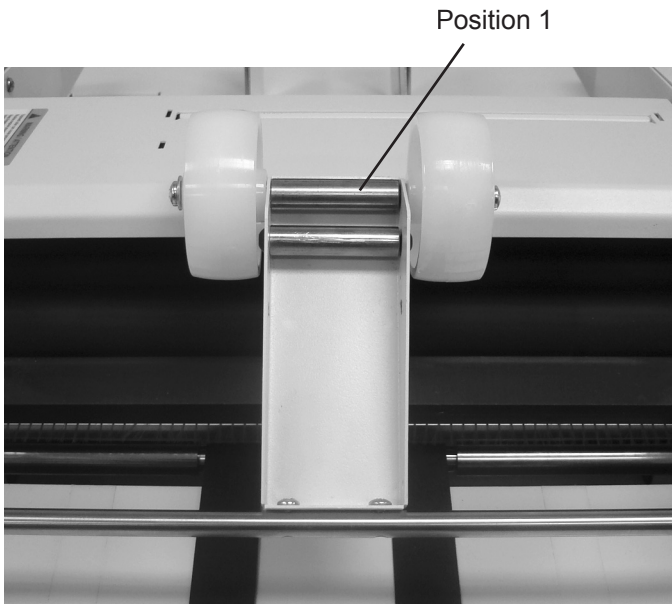

Fig. 13 - Standard Stacker Wheel Position

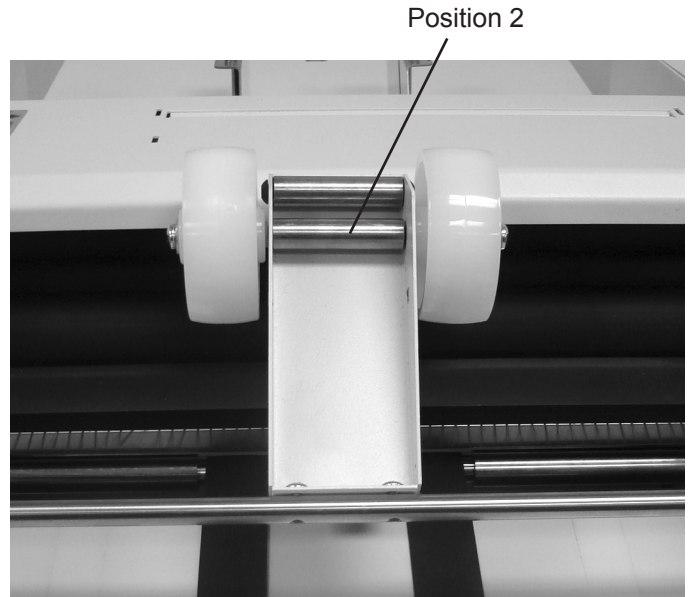

Fig. 14 - Thick Paper Weight Position

OPERATOR MAINTENANCE

1. It is recommended to let forms cool for one-half hour, from the laser printer, before folding. This allows toner to set on the forms and static electricity to discharge. A 400 Series Paper Jogger is recommended for best results. The Jogger squares the forms and dissipates heat and static created by laser printers.
2. Clean in-feed tires and fold rollers with Formax recommended roller cleaner & rejuvenator to remove paper dust and toner. A Formax Cleaner Kit is available from your dealer. A damp cloth with water is the best alternative.

CAUTION: Do not use any chemicals other than the roller cleaner & rejuvenator or water.

CLEANING PROCEDURES:

1. Make sure machine is turned off and unplugged. All folders have four (4) rubber rollers (Fig. 15).
2. Remove the upper and lower fold plates.
3. Using Formax roller cleaner, spray a new cotton cloth until the cloth is saturated. Wipe the wet cloth in a back and forth motion making sure to clean the entire surface of the fold and seal rollers. Next, use a dry cloth to wipe off excess toner. The cloth should be covered with black toner surplus from cleaning the rollers.
4. Make sure to run 10-15 sheets of blank copy paper to ensure all cleaner has been removed from the fold rollers. Running blank sheets will remove any excess residue of cleaner on the rollers.

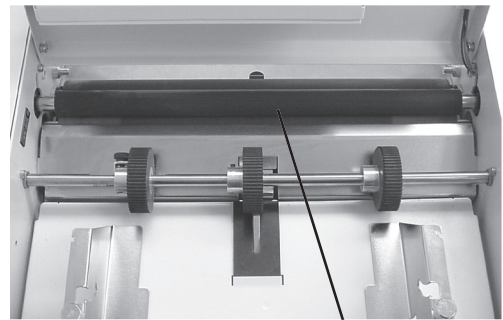

Fig. 15

Fold Rollers

TROUBLE-SHOOTING

TROUBLE	POSSIBLE CAUSE	REMEDY
Control panel lights are not illuminated.	No power at the wall outlet.	Check wall outlet.
	No power to the machine inlet.	Check power cord for frayed/broken wires.
	No power to the control panel.	Press the button on the circuit breaker.
	Internal electrical failure	Call for service
"Cover Open" light is on.	Cover open	Close cover
	Magnetic switch is broken.	Call for service
"Paper out " light is on.	In-feed tray is empty.	Place documents on the in-feed tray.
"Fault detect" light is on.	Paper jammed at exit of folder.	Remove paper and press "Reset".
Black marks on the folded paper.	In-feed tires, separator, and/or fold rollers are dirty.	Clean the parts with approved roller cleaner and rejuvenator.
Fold is skewed.	In-feed tray is out of adjustment.	Turn skew adjuster knob to remove the skew.
Stacker belts do not turn.	Broken drive belt, worn drive gear.	Call for service
Documents are wrinkled or crunched.	Fold plates are not inserted correctly.	Remove and reinstall fold plates. Be sure they're properly positioned.
	Piece of paper or other material is stuck in the fold plate.	Remove object from the fold plate.
In-feed tray lever does not work	Broken spring	Call for service
Double feeding forms	Documents stuck together	Jog forms to remove static electricity.
	Feed tire or separator worn	Call for service
Not feeding documents	Feed tire dirty	Clean feed tire
	Feed tire or separator worn	Call for Service