

# FORMAX<sup>®</sup>

---

7200 Series  
Mid-Volume Modular Inserting System

OPERATOR MANUAL  
FIRST EDITION

## Table Of Contents

<b>1 Introduction</b> .....	<b>3</b>
1.1 Pictograms .....	3
1.2 Notes on the use of this handbook .....	4
<b>2 Safety notes</b> .....	<b>4</b>
2.1 General safety notes .....	5
2.2 End of life .....	6
<b>3 Description of machine</b> .....	<b>8</b>
3.1 Description of operation.....	8
3.2 Identification of parts .....	9
<b>4 Control Panel</b> .....	<b>11</b>
4.1 The Job Screen.....	11
4.2 The Run Screen.....	12
4.2.1 The Run Screen displayed .....	12
4.2.2 To adjust the Envelope Inserter settings.....	13
4.2.3 To adjust the Document Unit settings.....	15
4.3 The Menu Screen.....	16
<b>5 Running an existing job</b> .....	<b>17</b>
<b>6 Switching the user</b> .....	<b>19</b>
6.1 How to switch the user .....	19
6.2 User access rights.....	19
<b>7 Creating a job</b> .....	<b>21</b>
7.1 Creating the Job Settings.....	21
7.1.1 Defining the mailset .....	22
7.1.2 Defining the fold .....	31
7.1.3 Defining the output settings .....	33
7.1.4 Saving the job .....	35
7.2 Creating an envelope .....	36
7.3 Creating a document.....	38
7.4 Creating an enclosure .....	40
<b>8 Loading the paper hoppers</b> .....	<b>41</b>
8.1 Loading the envelope hopper.....	41
8.2 Loading the versatile feeder hopper .....	42
8.3 Loading the flex folder hoppers.....	45
8.4 Paper Control Lever .....	48
8.5 Daily Mail (Handfeed).....	49
8.5.1 Stapling Restrictions.....	49
8.5.2 Using Daily Mail .....	49
8.5.3 Setting the Separator Gap (see also section 8.2 'Adjusting the Separator').....	50

<b>9 Operator Maintenance .....</b>	<b>51</b>
9.1 Cleaning the sensors .....	51
9.2 Clearing paper jams .....	57
9.3 Changing the feed tyres .....	59
9.4 Adjust the CIS reader.....	60
<b>10 Technical Specification .....</b>	<b>61</b>
10.1 Inserter head .....	61
10.2 Flex tower.....	66
10.3 Versatile feeder .....	68
10.4 Mechanical & Electrical .....	69
<b>11 Glossary of terms .....</b>	<b>70</b>

# 1 Introduction

With this inserter you have an advanced, medium-volume folding and inserting machine. Its modular construction allows up to 8 feed units to be fitted, with a maximum of 11 feed trays. Its sophisticated software control optimises the order and flow of documents for collating at the insert head before insertion into the envelope. All fold and adjustments take place automatically according to the requirements programmed in by the operator.

In order to ensure the long usage of this machine and its components, and above all the safe use of the machine, you must read and adhere to the operating instructions and safety notes. Always be aware of all warnings and notes that are mounted or noted on the machine itself.

All persons entrusted with the handling of this machine must also be familiar with the operating manual. Save this handbook carefully, so that the information it contains may be available at all times.

## 1.1 Pictograms



**General Warnings**



**Warning of danger from electricity or electrical shock**



Information / Note indicating important information regarding the handling of the machine.

---

## 1.2 Notes on the use of this handbook

This document contains all general information and explanatory text necessary in order to be able to carry out the operation of the machine.

When some action is expected from the operator, this will always be explicitly stated, and where relevant, accompanied by an illustration or graphic.

Always read through each step, so that you will obtain all of the necessary information. Do not anticipate what you believe will follow in the handbook: It will prevent you from making mistakes!

### Chronology and Reference

This handbook is structured chronologically, and therefore ordered sequentially for the operationally ready machine. It assumes that the machine has been installed in the correct environment by an Authorised Service Engineer and that the operator or his or her supervisor has had a degree of operator training.

When you are unfamiliar with the machine, it is best to read through the handbook from beginning to end. You will be guided step by step, and in this way you can easily and quickly have the machine in operation.

If you are already familiar with the machine, it will make things easy if you use this handbook as a reference work.

## 2 Safety notes

---

For your own safety and the operating safety of the machine, read the following notes carefully before starting your machine. Always be aware of all warnings and notes that are mounted or noted on the machine itself. Save this handbook carefully, so that the information it contains may be available at all times.

The machine is of advanced construction and reliable in operation. Nevertheless, the device does present hazards when operated by untrained personnel. The same applies to use that is inappropriate and not in keeping with its intended purpose.

**In not adhering to this handbook, there is the danger of**

- an electrical shock,
- injuries from the intake at the rotating rollers,
- damage to the machine.

**IMPORTANT: To stop the machine in an emergency,  
open any cover.**

## 2.1 General safety notes



### Caution!

Please, read these notes with care.  
Save these instructions for later use.  
All notes and warnings found on the machine are to be followed.

Installing  
the  
machine

**Important! The machine must be installed only by an Authorised Service Engineer.** A safe, level position is necessary, when installing the machine, with sufficient space all round to operate it. The machine is to be protected from moisture. If moving the machine, ensure that the castor brakes are **off**, and push on the stand, not the machine.

Ensure there is at least 1 metre of free space between the operator side of the machine and a wall or barrier. To provide access to the mains switch, the opposite side of the machine must be at least 150mm from a wall or barrier. Do not place surrounding furniture or other objects where your path may be obstructed.

Electrical  
danger

The machine may only be connected to a voltage of 230V/50Hz or 115V/60 Hz, depending upon model. The mains plug may only be connected with a socket having an installed protective contact! The protective effect will be compromised by the use of an extension line without a protective grounding conductor. All interruptions of the protective grounding conductor, within or outside of the machine, are prohibited. The device is double pole fused! When fuse failure occurs, electrical machine parts can still carry voltage. When making the connection to the mains power, be aware of the connection values on the nameplate. Inspect the voltage setting on the device's power input module. Run the supply lines in such a way, that no-one may trip over them. Do not place any objects upon the supply line. When the machine is not in use over a long period of time, it should be disconnected from the power supply. In this way, damage would be prevented in the event of excess voltage. Protect the device from moisture. When moisture enters the machine, there is the danger of electrical shock. Never open the machine except the top cover. For reasons of electrical safety, the machine may only be opened by authorized Service Agents.

Operating  
safety

Never reach into the machine when it is running! This could only occur if a safety interlock were to fail. The danger of injuries exists, through pulling in and crushing on the rotating rollers. In addition, keep long hair and parts of loose clothing far from the machine in operation. **If a safety interlock fails, your Service Agent must be contacted immediately!** In order to prevent damage to the machine, only factory authorized accessory parts should be used.

Cleaning  
the  
machine

Prior to cleaning the exterior of the machine, it should be disconnected from the power supply. When cleaning the machine, do not use liquid or spray cleaners, but only a cloth dampened with water.

Cleaning  
sensors

When cleaning sensors use **only** non-flammable airdusters, eg. part number 9103707C. Other types may use flammable propellants, which could result in fire or explosion.

Allow machine to be checked by the Service Agent	<p>In the following cases, the mains plug must be unplugged and the device left for the authorized Service Agents:</p> <ul style="list-style-type: none"> <li>• When the mains cable or plug is worn or damaged.</li> <li>• When water or other liquid has entered the device.</li> <li>• When the device does not function properly, in spite of following the instructions provided.</li> <li>• When the device has fallen down or the housing is damaged.</li> <li>• When there are noticeable differences in the normal operation of the machine.</li> </ul>
Spare Parts	When repair work is carried out, only original spare parts or spare parts corresponding to the original parts may be used.
Repairs	<p>Do not disassemble the machine any further than is described in this handbook. Other than the top cover, the opening of the machine by unauthorized personnel is not permitted. Repairs may only be carried out by an authorized Service Agent.</p> <p>Modification is not permitted: For safety reasons, your own reworking and modifications are not permitted.</p>



Please contact your Service Agent, for all questions relating to service and repair. In this way, you ensure the operational safety of your machine.

---

## 2.2 End of life

The objectives of the European Community's environment policy are, in particular, to preserve, protect and improve the quality of the environment, protect human health and utilise natural resources prudently and rationally. That policy is based on the precautionary principle and principles that preventive action should be taken, that environmental damage should as a priority be rectified at source.

Separate collection of waste is the precondition to ensure reuse and recycling of waste that is generated at the disposal of electrical or electronic equipment and is necessary to achieve the chosen level of protection of human health and the environment in the European Community.

More particularly, certain materials and components of waste electrical and electronic equipment needs selective treatment as their injudicious handling or disposing of on or into land, water or air would represent a major threat to the environment and human health.

In order to facilitate collection and treatment separated from normal domestic waste, electrical and electronic equipment is marked with the following logo:

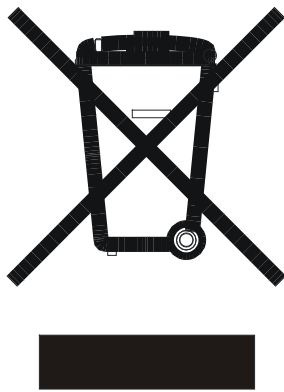

Do not mix with normal domestic waste.  
Please use the subjoined return or  
collection system dedicated to electrical  
and electronic waste.

Equipment produced after  
August 13 2005

Not only are you by law not allowed to dispose of the waste equipment via other waste-streams, but we encourage you to actively contribute to the success of such collection and to the common good and better quality of life of present and future generations.

For more information on the correct disposal of this product please contact your local dealer.



## 3 Description of machine

### 3.1 Description of operation

The function of the machine is to fold forms to 'C', 'Z', 'V' or double forward fold, either singly, in fixed multiples or in varying groups. Enclosures such as inserts, BR envelopes etc. may be added. Folded forms and enclosures are collated in the collation area in the inserter head before insertion into the envelope. Forms may be inserted without sealing the envelope for subsequent checking or hand insertion.

There is a batch processing facility, allowing a preset number of cycles to be completed before the machine automatically stops.

The machine is OMR/Barcode compatible for use with a mark-reading feeder or tower folder, allowing a group of forms to be collated on the track prior to folding. A number of barcode symbologies may be read.

The machine consists of a number of modules, depending upon the build ordered - these modules are briefly described below:

- **Inserter head** - Collates all documents in a pocket before insertion, feeds the envelope, inserts the pack and seals the flap.

**Versatile-Feeder** - Feeds shortform inserts (cards, BR envelopes, booklets etc.) onto the track for subsequent insertion. Available as a single feeder with one feed hopper or a double feeder with two feed hoppers. An OMR/Barcode version (with one feed hopper) is also available.

- **Feeder Folder** - Mounts on the track, either in conjunction with a tower (see below) or as the last station. Fitted with one feed hopper, and folds forms up to 14" long using a 2-plate folding mechanism. An OMR/Barcode version is also available.

- **Tower** - Mounts at the end of the machine. Folds documents either separately or in groups, using an accumulator if required. Fitted with either one or two feed pods, each consisting of either 2 x 500 sheet trays or 1 x 1000 sheet tray. Uses a 3-plate folding mechanism. An OMR/Barcode version is also available.

The machine is equipped with PC controlled operating software from where jobs can be programmed and run. The number of jobs that can be programmed is limited only by the capacity of the PC. Input is via touch-screen monitor or keyboard/mouse.

A daily post function can be used as an optional feature on a tower. This allows groups of documents, stapled or loose, to be hand-fed; they will then be folded and inserted into an envelope. If other hoppers are loaded, further forms can be collated.

No manual setting of the fold plates or envelope closer is required, these being adjusted automatically according to the settings in the selected program.

An optional output conveyor can be specified, to replace the standard receiving tray. This is available in two lengths.

## 3.2 Identification of parts

The main parts of the machine are shown below.

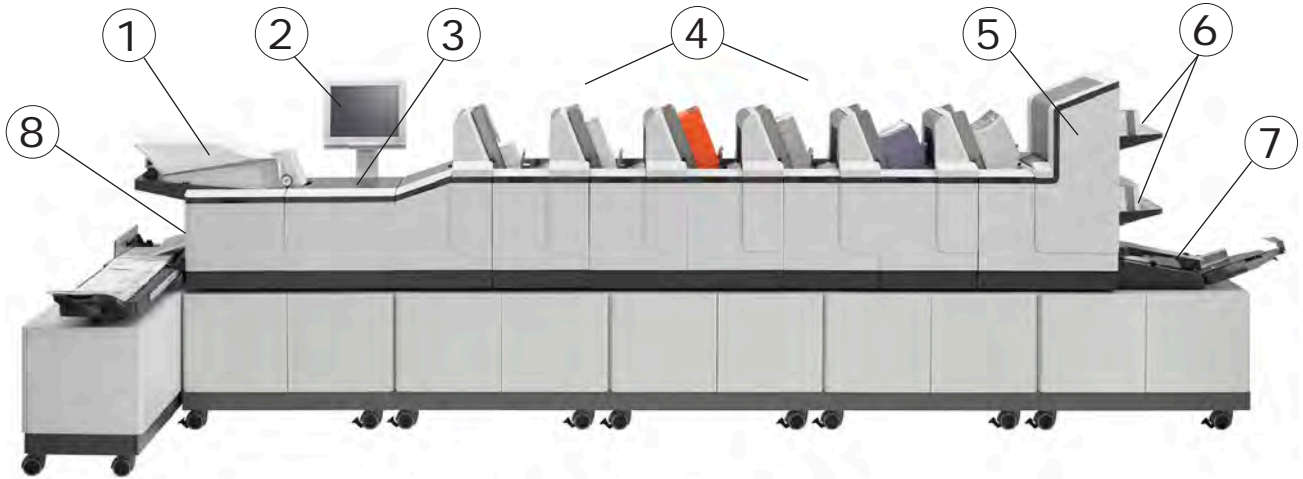

### 1 Envelope feeder

Holds up to 800 envelopes (DL). Fitted with a sensing conveyor that operates on demand to move the envelope stack forward.

### 2 Touch-screen monitor

Runs the IMOS operating software and responds to button pushes. A keyboard and mouse are also included.

### 3 Collation and insertion area

Folded forms, either singly or in groups, are collated here into one pack, along with enclosures. The pack is then inserted into the envelope.

**Note: Items 1, 2, 3 & 8 are all part of the Insertion Head Unit.**

### 4 Versatile Feeder

These are track mounted units, with an end-station variant also available. Up to 8 may be fitted (7 if a flex tower unit is fitted - see below).

The Versatile Feeder feeds enclosures such as inserts, flyers, BREs etc. The hopper holds up to 1000 80gsm inserts. A mark reading variant for OMR/Barcode/2D is also available.

### 5 Flex Tower

This is a folder unit and is only available as an end module. It can be fitted to the insertion head on its own, or in conjunction with Versatile Feeders. It is fitted with various options of feed trays and an accumulator (see following page).

## **6 Feed Pods**

Fitted to the Flex Tower. Either a 1-Tray or a 2-Tray Flex Tower is available. Each one is fitted with either 2 x 500-sheet trays, or 1 x 1000-sheet tray; both variants can be mark reading as an option.

## **7 Accumulator**

Fitted to the Flex Tower and allows groups of forms to be collated together before folding as a group. It is an optional item, it is also fitted with a diverter tray.

## **8 Closer/Eject Area**

This is where the envelope flap is closed and sealed before ejected the filled envelope into a receiving tray or onto a conveyor.

## 4 Control Panel

### 4.1 The Job Screen

This is the screen displayed when the machine starts up.

The screenshot shows the Job Screen interface. At the top, there are buttons for 'Jobs', 'Run Screen', and 'Menu'. On the right side, there are buttons for 'Internal' and 'Shut Down'. The 'Jobs' button is circled in red, with a callout 'See section 5'. The 'Internal' button is also circled in red, with a callout 'See section 6'. The main area is divided into two panels. The left panel, titled 'Jobs', has a table with columns 'Name' and 'Date Created'. It lists several jobs: 'C5 Test Job', 'Mailshot\_Q3' (highlighted in yellow), 'Joe C #10 Test', and 'Billing Feb-Mar'. A callout 'List of existing jobs—see section 5' points to this list. The right panel, titled 'Mailshot\_Q3', shows job details: 'Main document: a, A4 (H297, W210)', 'Fold Type: C-Fold', and 'Envelope: .DL Plus-114mm (H114, W235)'. Below the details is a technical drawing of a machine configuration, with a callout 'Graphic shows machine configuration' pointing to it. At the bottom left, there are buttons for 'Create job', 'Copy', 'Edit', and 'Delete'. The 'Create job' button is circled in red, with a callout 'See section 7'. At the bottom right, there is an 'Accept' button.



See section 5 for running an existing job directly from this screen.

## 4.2 The Run Screen

### 4.2.1 The Run Screen displayed

This is the screen you will see after an existing job has been selected in the Job Menu.

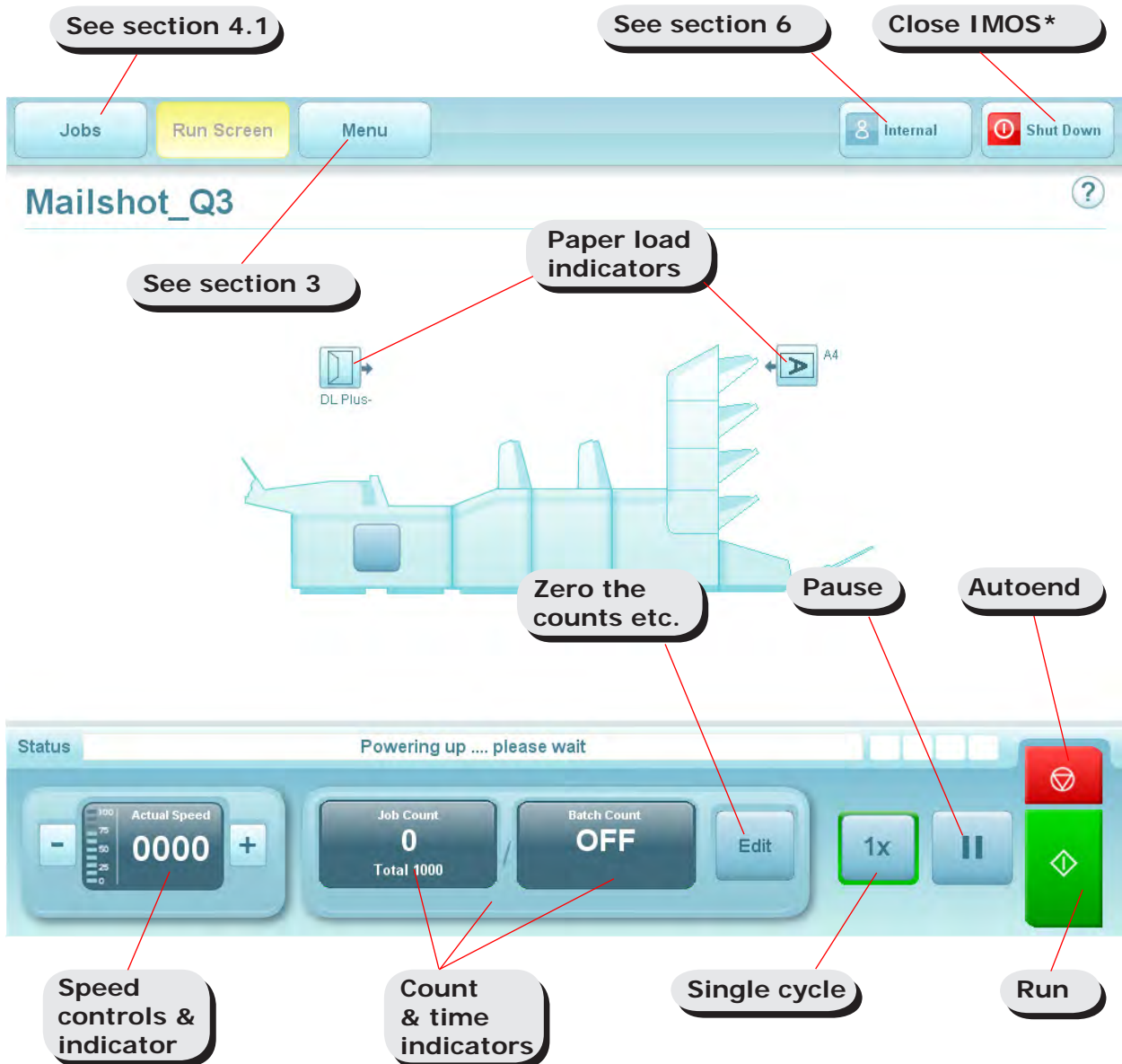

\* This button closes down the IMOS operating software - it does **not** switch the machine off.

To change the current user or job, click on the buttons and you will be presented with a list of all those that have been created, and allow you to select any one. Note that to change to a different user will require the appropriate password to be entered. To view and adjust the settings for the envelope and document inserters, click on the relevant part of the machine graphic (see the following pages for details).

## 4.2.2 To adjust the Envelope Inserter settings

### Unit Fine Tuning



All fine adjustments apply only to the current job and will not affect any other jobs.

Hardware Fine Tuning: Module 0: Head		
Collate Pkt. Adj (0.1mm)	0	- +
Fingers Adj (0.1mm)	0	- +
Seal Time (ms)	40	- +
Adjust wetter start (mm)	0	- +
Adjust env seal pos (mm)	0	- +
Adjust envelope stop (mm)	0	- +
Insert in env position (mm)	0	- +
Adjust env reverse pos (mm)	0	- +
Linear Speed	Auto	Select
Envelope Blower	Low (default)	Select
Finger Sequence	Outers first (default)	Select
Env Conveyor Drive Delay	0 (default)	Select
Adjust pawl pause pos	0	- +
Conveyor Pulse Multiplier	1	- +

Select the inserter icon on the machine graphic in the Run screen to display the fine tuning screen. Select **Hardware Fine Tuning** to display further information. You can change:

a: The width of the collate pocket guides.

b: The overall width of the insert fingers.

c: The time allowed for the flap to seal before the envelope is ejected.

d: Adjustment of the point at which the wetter beam drops to wet the flap. +ve increases wetting in 1mm steps (moves start point

towards insertion area).

e: Adjustment of the point at which the wetter beam lifts. +ve increases duration, ie. a greater length of flap is wetted before the beam is lifted.

f. Adjustment of the amount of envelope travel into the sealing rollers. +ve = further forward, away from exit direction.

g. Adjustment of the envelope stop position for insertion. +ve = further forwards, towards exit direction.

h. Adjustment of the amount of insertion of the insert pack into the envelope. +ve = further forwards past the flap crease.

i. Adjustment of the amount of envelope forward travel after flap wetting, before reversing to enter the sealing rollers. +ve = further forward into the output rollers, towards the exit direction. **Note: for high-window envelopes, this should be set to 20 - 50mm +ve.**

When all adjustments are complete, select the 'Unit' button for hopper settings, as described overleaf.

## Hopper Fine Tuning



From here you can adjust hopper settings. Select the envelope icon on the machine graphic in the Run screen then **Document Fine Tuning** to display further information. You can change:

a: Whether or not the envelope is sealed. Select 'Off' if, for example, later hand insertion of an insert or any other item will be required.

b: The setting of the amount of envelope deskew required. Note a higher level will slow the machine more.

**Important: All fine adjustments apply only to the current job and will not affect any other jobs.**



***Important: All fine adjustments apply only to the current job and will not affect any other jobs***

---

### 4.2.3 To adjust the Document Unit settings

#### Unit Fine Tuning



**The fine tuning options available will depend upon whether a Versatile Feeder or Flex Folder is fitted.**

Select the document or insert icon on the machine graphic in the Run screen to display the fine tuning screen.

#### Hopper Fine Tuning

Config Fine Tuning: Mailshot_Q3			
Feed Control Mode	Feed always	Off	On
Doubles Detect	On (Optical)	Select	
Deskew	Low	Select	

From here you can adjust hopper settings. You can select:

a: Feed Always or not. If you select **Off**, the unit is disused until it is turned back on again.

b: Whether doubles detection is turned on or off. Turn off if booklets or very thick inserts

are being fed. **Note:** refers only to optical detection - mechanical detection may also be fitted.

c: **Only for Reading units.** Retrieve CIS Image - if selected, images of the label as seen by the CIS reader will be displayed. The images will be of the final 2 documents in the group and can be useful for error checking by confirming that the whole label was read, for example, or comparing the 2 images.



**Important: All fine adjustments apply only to the current job and will not affect any other jobs**



### 4.3 The Menu Screen

The Menu screen allows various functions to be selected. These functions are described in detail further in this document.

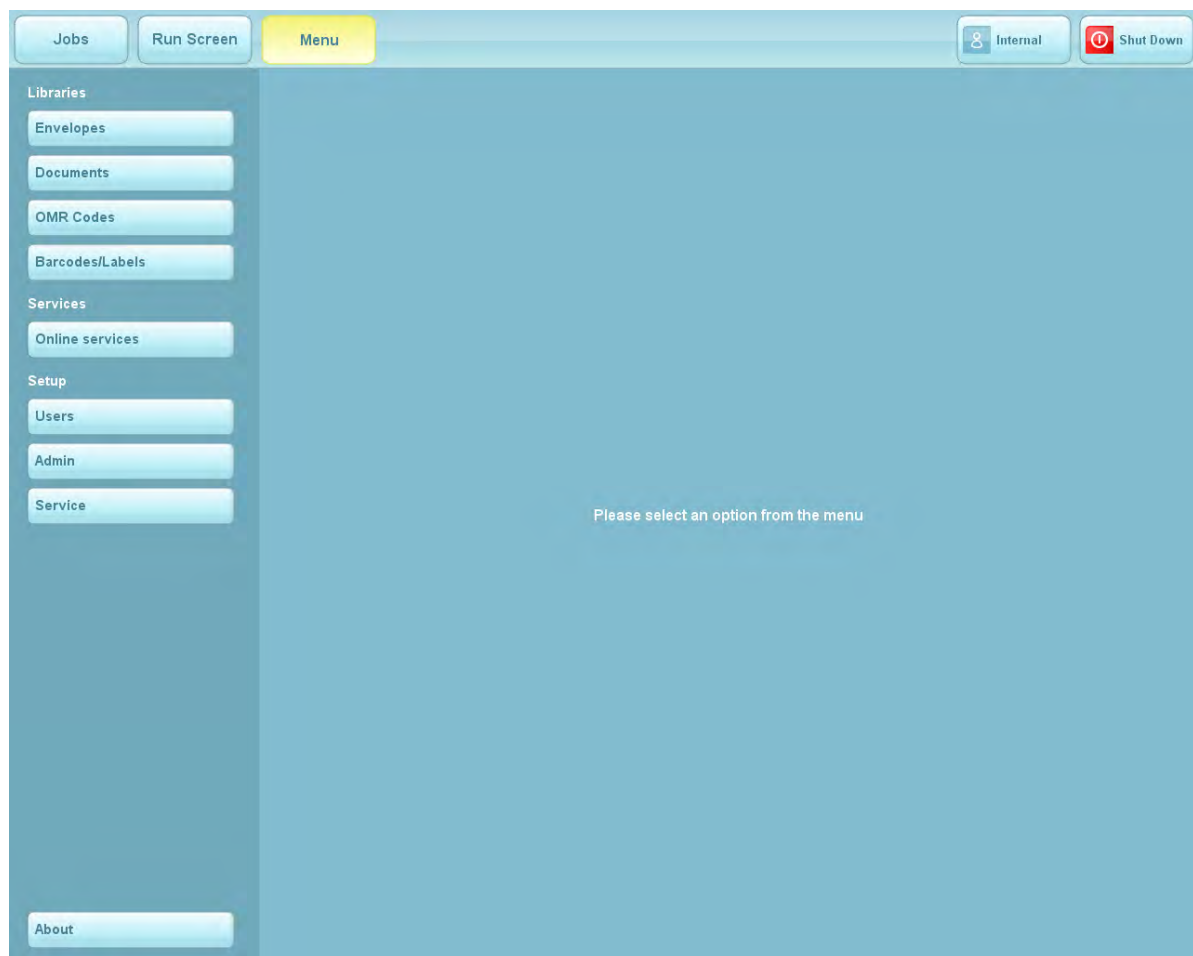

## 5 Running an existing job

This section describes running an existing pre-programmed job. To create a new job, see section 7.

If the IMOS operating software is not already running, it must be started using the icon on the monitor screen. To access the PC to switch it on, open the cupboard below the inserter head.

Before running a job, the paper hoppers must be loaded with stationery - see section 8 for details.

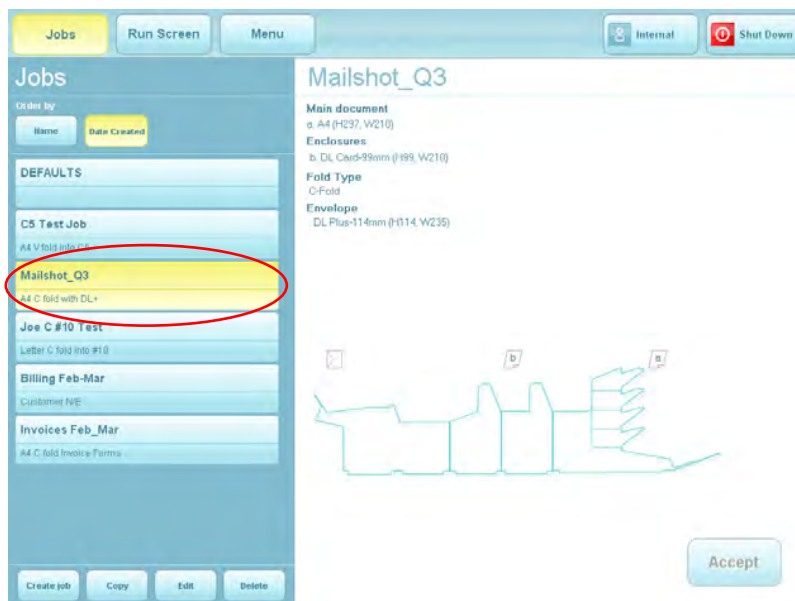

1 If the Job screen is not already displayed, press the **Jobs** button at the top and select the required job from the list (use the scroll arrows if needed).

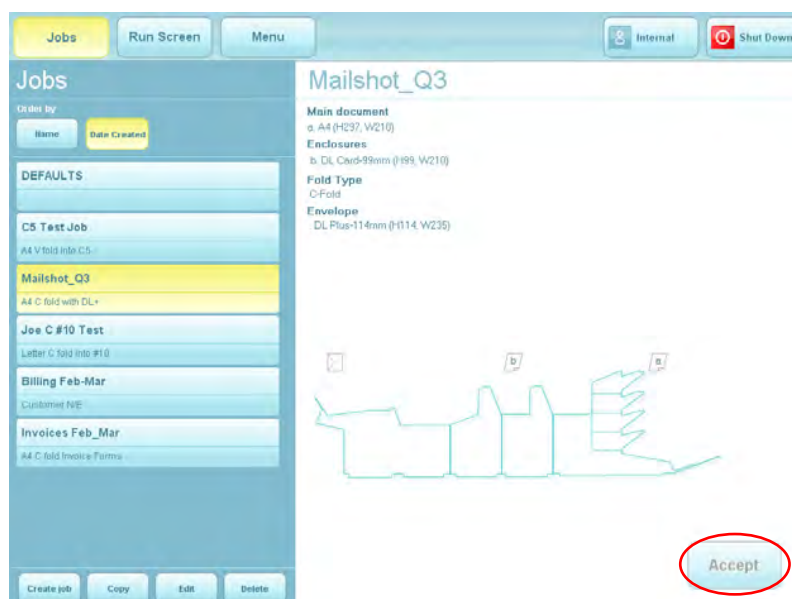

2 Summary of selected job is shown.

3 If you are happy with your selection, press **Accept**, otherwise, select another job.

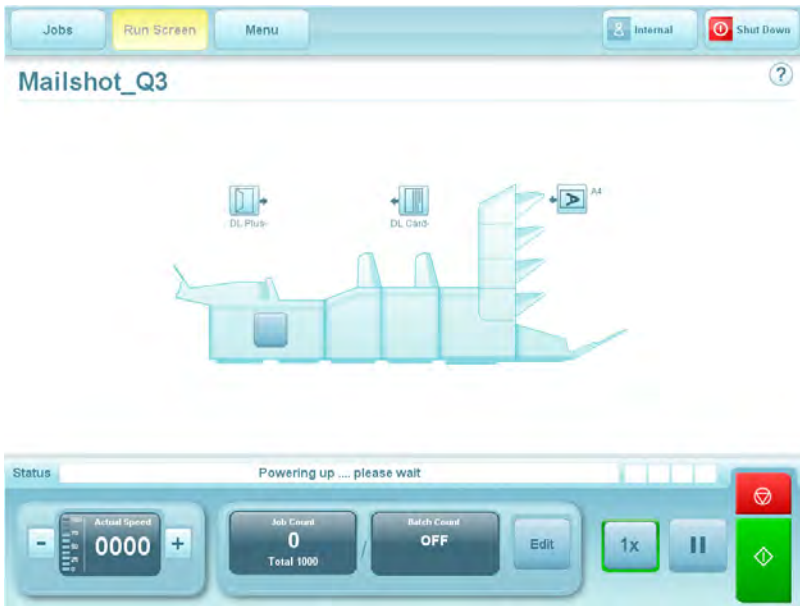

4 Load the paper and envelopes in the hoppers indicated.

5 Press the Run button to begin operating.

See also section 4.2 for a full description of the controls.



Paper is normally loaded in the Tower face-up and feet-first if non-reading, face down and head-first if reading. **This may vary:** see also appendix A.

## 6 Switching the user

### 6.1 How to switch the user

Each user has their own password and access rights, allocated by the Supervisor. To switch user, the password must be known.

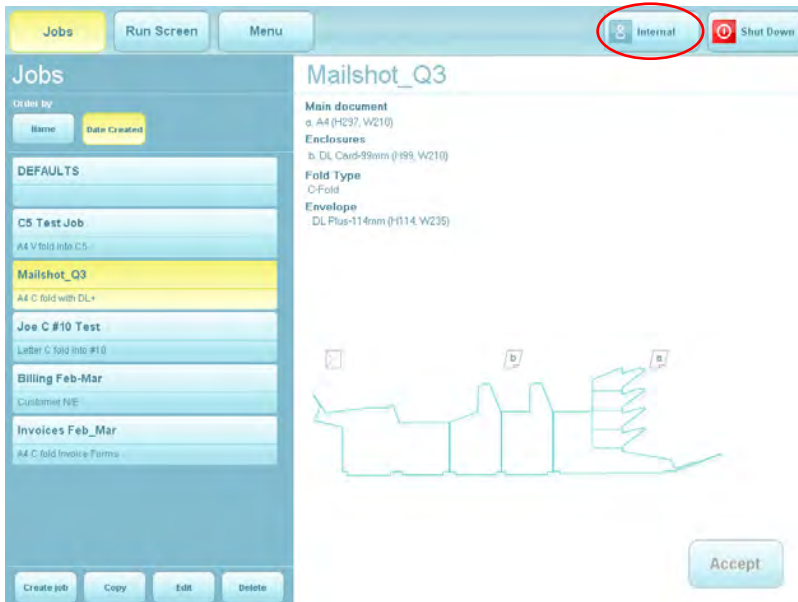

1 Press the Switch User button in the Job screen

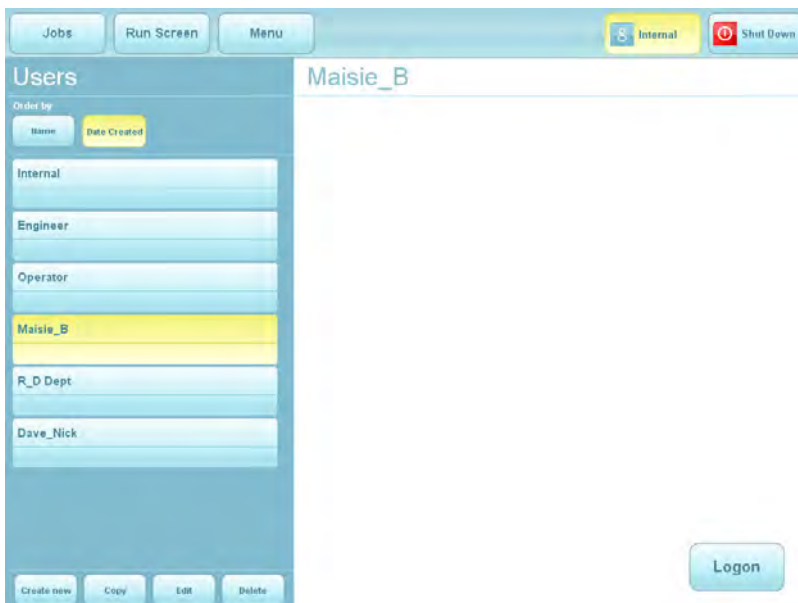

2 Select the user from the list. Use the scroll arrows if necessary.

3 Press the **Logon** button.



4 Enter the password using either the keyboard or the on-screen keypad.

The user has now changed.

## 6.2 User Access Rights

There are 4 levels of access rights that can be allocated to each user. These are described below:

Rights	Operator	Expert Operator	Engineer	Supervisor
Change Jobs	Y	Y	Y	Y
Run Machine	Y	Y	Y	Y
Programme Jobs with Wizard	N	Y	Y	Y
Add items to Libraries from Wizard	N	Y	Y	Y
Add Items to Libraries from Outside Wizard	N	N	Y	Y
Mechanical Fine tuning	N	N	Y	Y
Document Fine tuning	N	Y	Y	Y
Enter Service Menu	N	N	Y	X
Enter Admin Menu	N	N	X	Y
Avoid PC shutdown on IMOS Exit	N		Y	Y

## 7 Creating a job

Creating a job consists of a number of steps:

- Defining the Mailset (Envelope, document & enclosures)
- Defining the Fold Settings
- Setting required Output Options
- Saving the Job to a Jobname

When defining the Document in the Mailset, OMR or Barcode definitions can be enabled if required.

**Note that for an OMR or Barcode definition to be used it must first have been created - see section 7.3.**

### 7.1 Creating the Job Settings



1 Press the **Create Job** button in the Job screen.

2 Press the **Auto-matic** button.

You will now need to define the mailset (envelope, documents and enclosures). This is described on the following page.

## 7.1.1 Defining the mailset

### Selecting the envelope

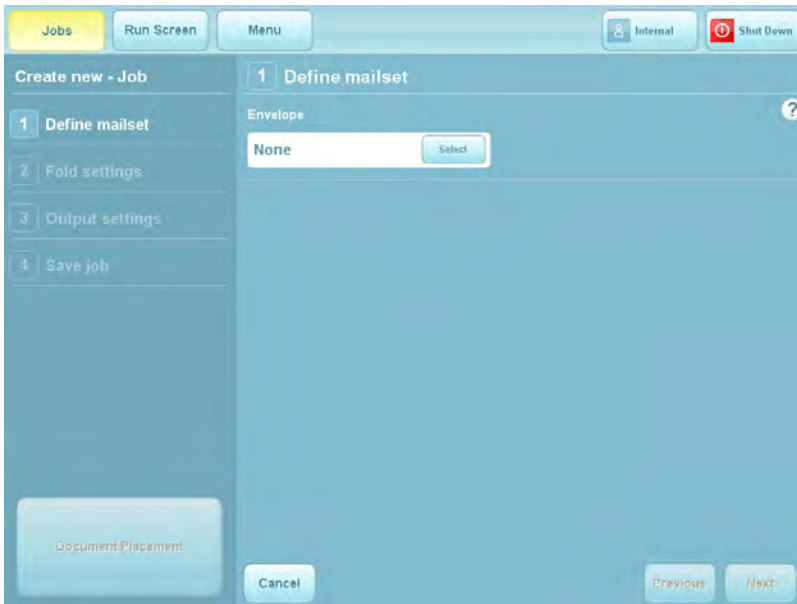

3 Press the Select button to choose an envelope from the available library.

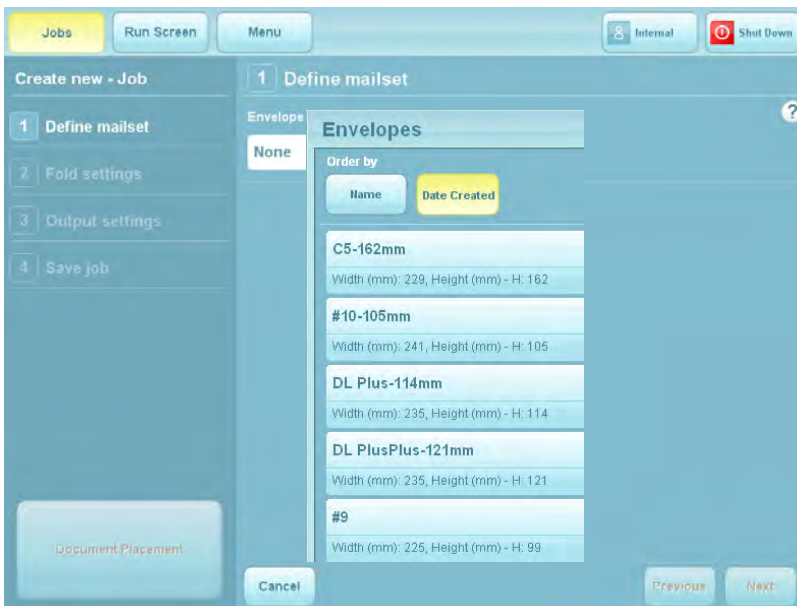

4 Select the required envelope from the library and press the **OK** button.



If there are no envelopes in the library, or if you wish to create a new one, see section 7.3.

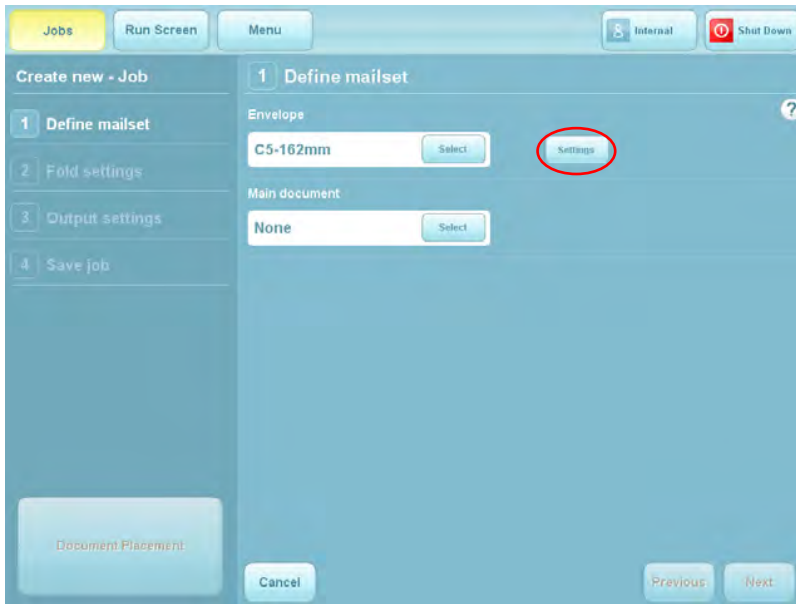

5 You now have a choice: carry on to select a document, or further define the envelope usage, ie. sealing mode and deskew.

The following assumes you want to further define the envelope usage. When you have finished you will return to the screen shown here.

Press the **Settings** button.

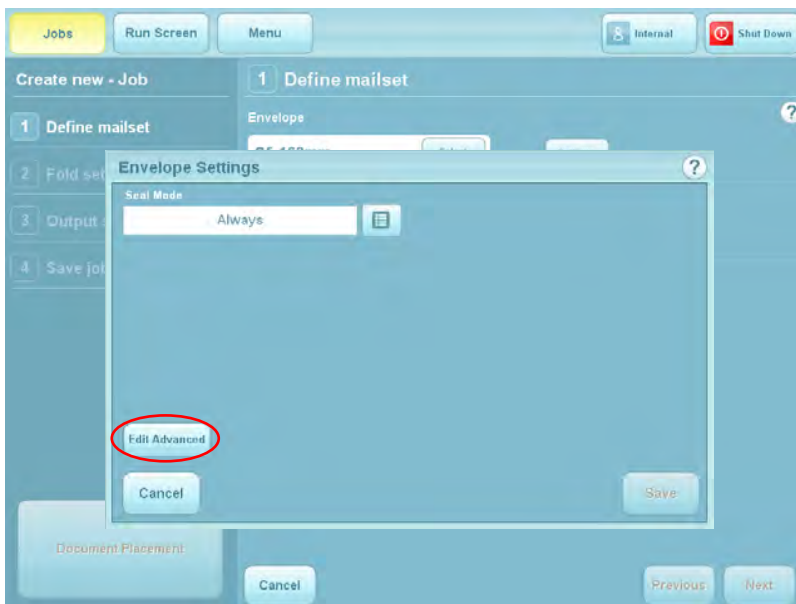

6 Select the required Sealing mode (usually this will be 'Always on').

Press the **Edit advanced** button if you wish to change the deskew setting.



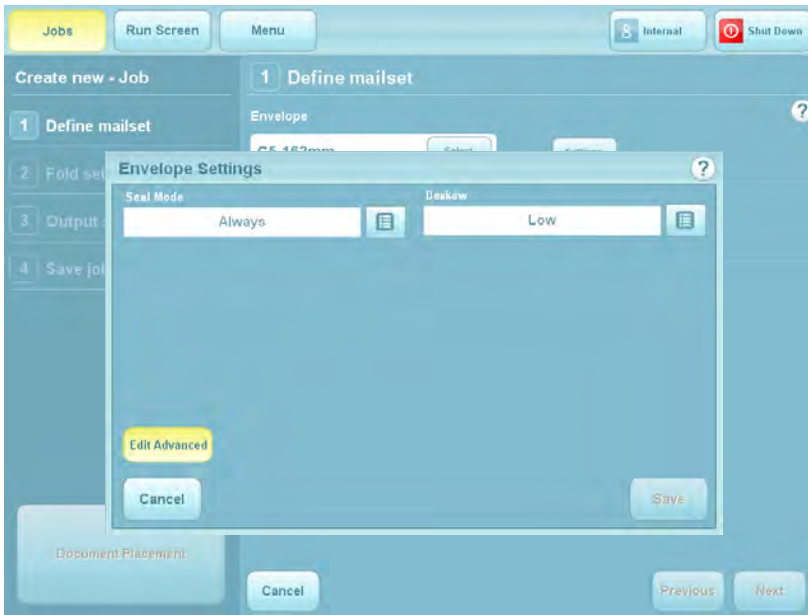

7 From here, you can turn adjust the degree of deskew, or turn it off if you require. This might be done to speed the machine up if, for example, an envelope is unlikely to skew, eg. a C5 or other longer envelope.

The default deskew setting is 'Low'.

## Selecting the document

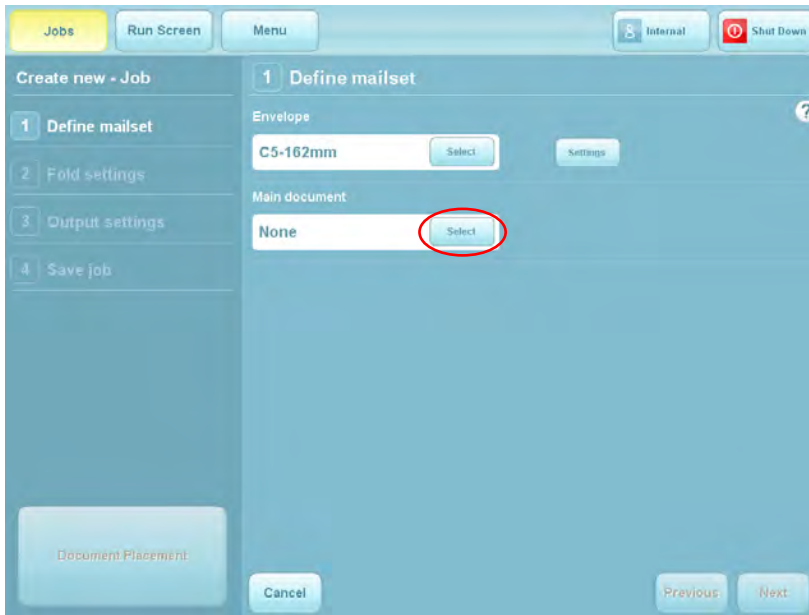

8 Press the **Select** button to choose a document from the available library.



9 Select the required document from the library and press the OK button.



If there are no documents in the library, or if you wish to create a new one, see section 7.4.

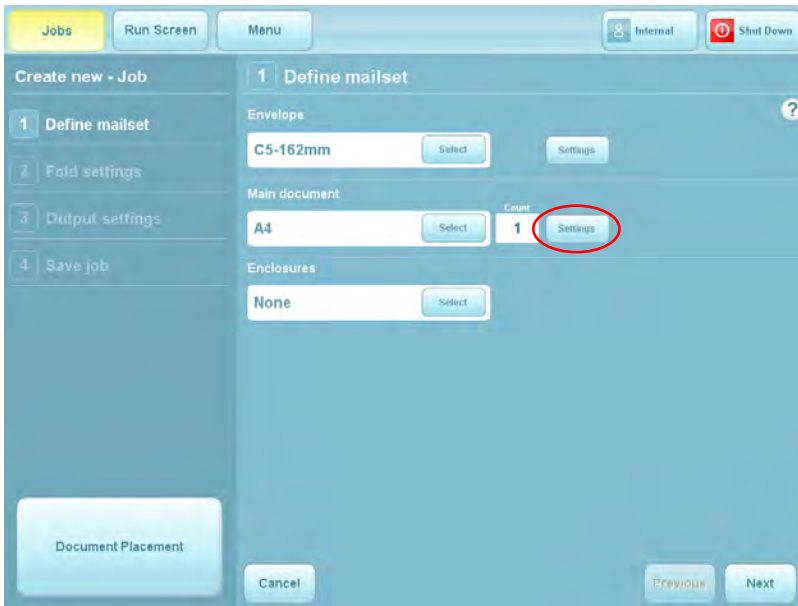

**10** You now have a choice: carry on to select enclosures, or further define the document usage, eg. form count, cascading, hand-feed etc.

The following assumes you want to further define the document usage. When you have finished you will return to the screen shown here.

Press the **Settings** button.

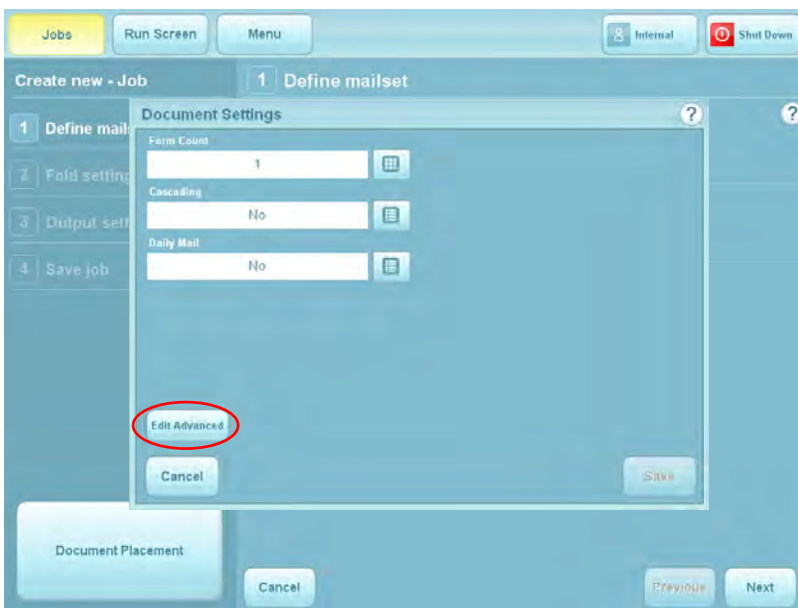

**11** Adjust the forms count if using multiples, whether or not cascading is to be used, and whether or not daily mail (hand-feed) is to be used. Press the **OK** button when done.

For further settings, press the **Edit Advanced** button.



**12** If you wish to choose an orientation other than the auto-selected default, press Auto to enable the selector button.

If required adjust the degree of deskew, or turn it off if you require, for example if a document type is found to feed reliably without skewing.

Thickness doubles can currently be checked optically only on a flex folder, or turned off, if for example, documents are substantially different from the calibration document, such as abnormally dark with heavy printing.

Selecting 'Auto' allows the software to choose between optical and mechanical checking if the document is moved to a versatile feeder fitted with a mechanical system.

Feed control mode is 'Feed Always' as default, but can be turned off to disable the hopper. It can also be set to 'Selective Feed' for reading-enabled units. This works in conjunction with 'Item ID' - see below.

Item ID allows you to define an ID number for the document which accords with the relevant Select mark in the OMR or Barcode label. This will then feed the document when that mark is read.

Sequence handling mode determines how sequence marks (if used) are handled when a document set is broken up (for example, to change a job in the middle of a document set). The mode must be set to 'Full' for the first pass, and then changed to 'Mailset' for the second pass after the job has been changed. The machine will not then expect an unbroken sequence.

## Selecting the enclosure

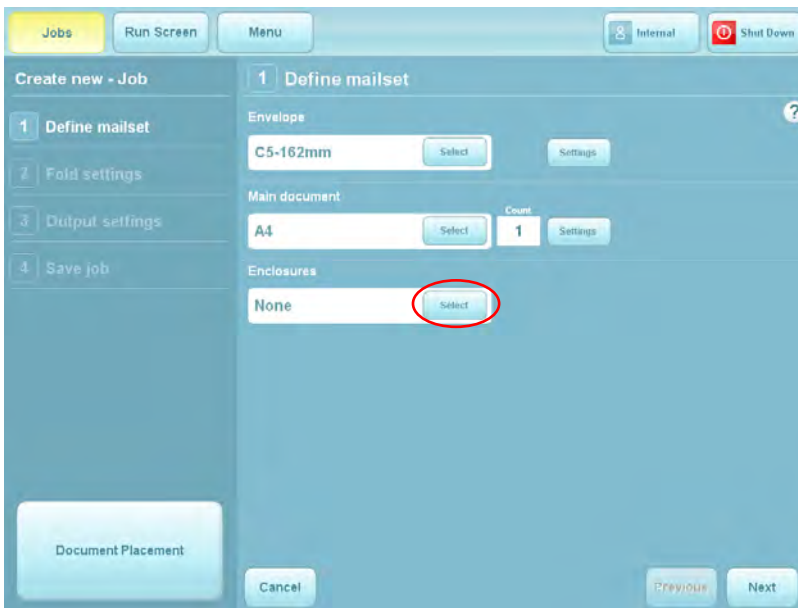

**13** If you are using enclosures (inserts, BREs, booklets etc.), press the **Select** button.

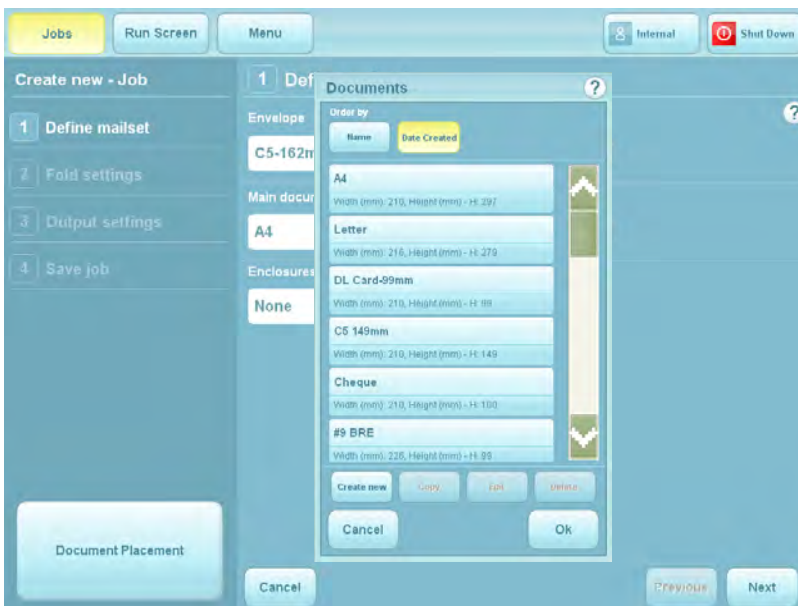

**14** Select the required enclosure from the library and press the **OK** button.



If there are no enclosures in the library, or if you wish to create a new one, see section 7.5.

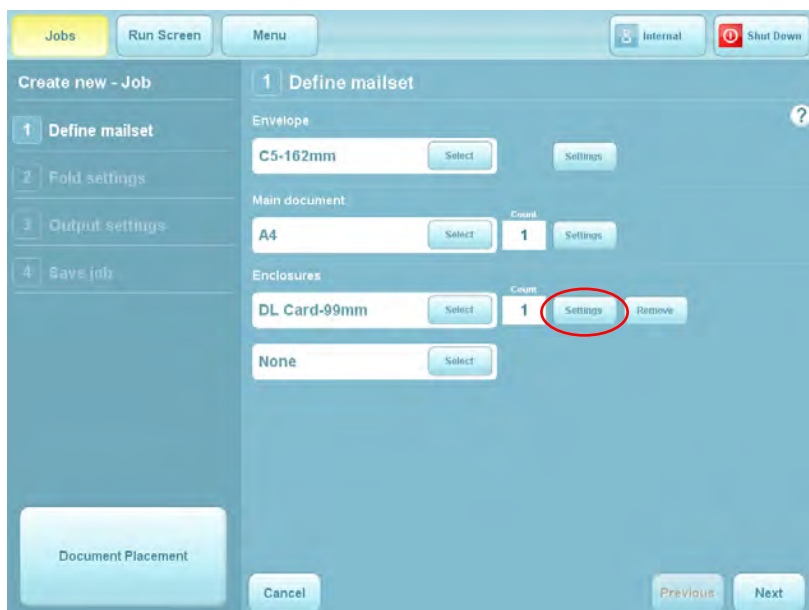

**15** You now have a choice: carry on to select further enclosures if required, remove the enclosure you have selected, or further define the enclosure usage, eg. form count, cascading, hand-fold etc.

The following assumes you want to further define the enclosure usage. When you have finished you will return to the screen shown here.

Press the **Settings** button. **Settings and Advanced Settings are same for enclosures as for documents - see steps 12 & 13.**



Paper is normally loaded in the Tower face-up and feet-first if non-reading, face down and head-first if reading. **This may vary:** see also orientation chart in section 8.3.

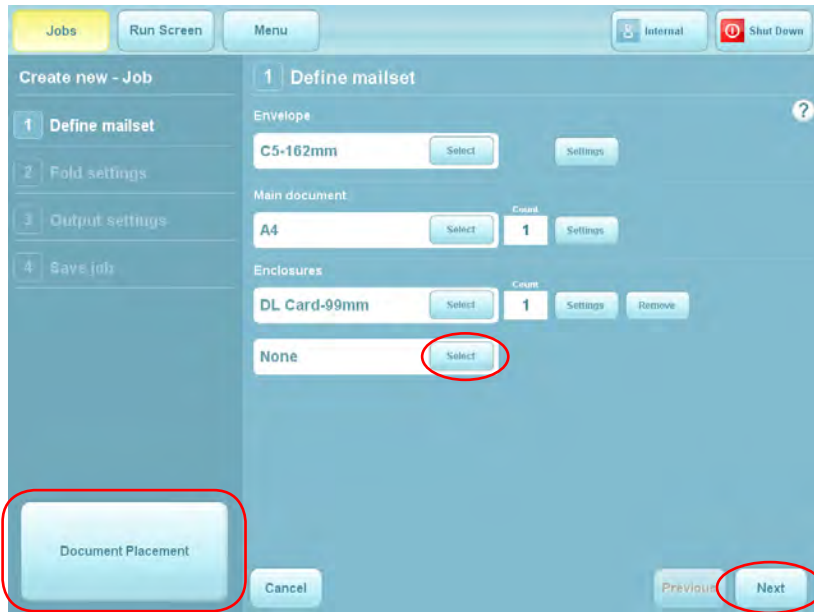

**16** If further enclosures are required, press the Add button and repeat steps 13 to 18.

Repeat as required up to the limit of available stations.

You now have a choice: to proceed and move on to Fold Settings, or to assign the documents/enclosures to specific hoppers.

The following assumes you want to assign the documents/enclosures to specific hoppers. This will override the hopper that the software automatically assigns.

**If you do not want to assign the documents/enclosures to specific hoppers, press the *Next* button shown in the previous screen.**

Otherwise, press the **Document Placement** button shown in the previous screen. This will display a selector box:

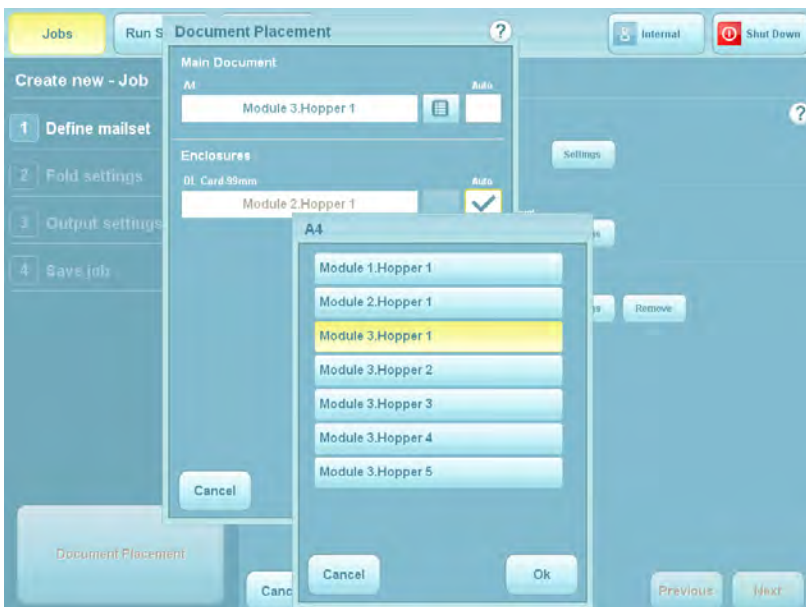

**17** Deselect 'Auto' to enable the selector box.

Select the hopper that you wish to assign the relevant document to and press the **Ok** button.

The hopper is now assigned to that document.

The mailset is now defined, and the screen will show that this is ticked.

**You will now define the fold settings.**

### 7.1.2 Defining the fold

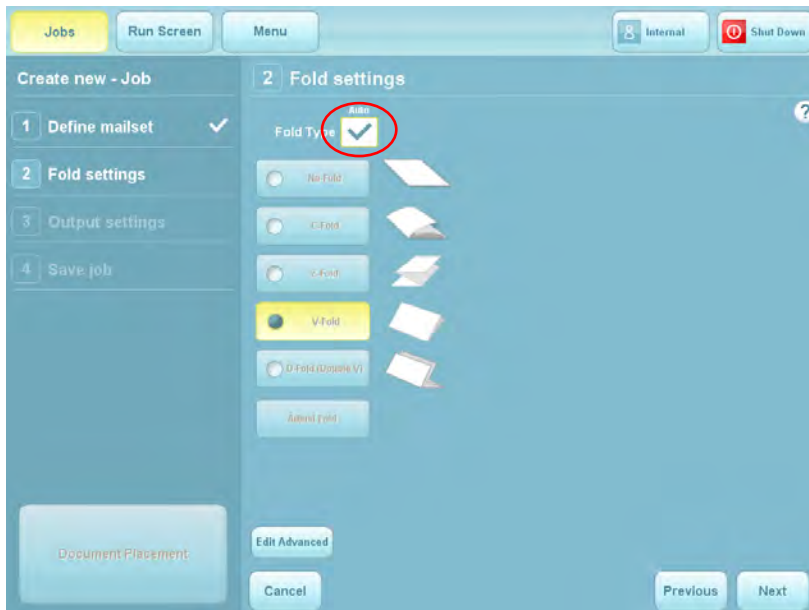

**18** The machine will automatically select the optimum fold type. If you wish to change this, de-select 'Auto' and set the required fold. **Caution: the machine may not perform properly if you change the fold type wrongly.**

If you wish to make adjustments to the fold lengths, or just check them, press the **Adjust fold** button.

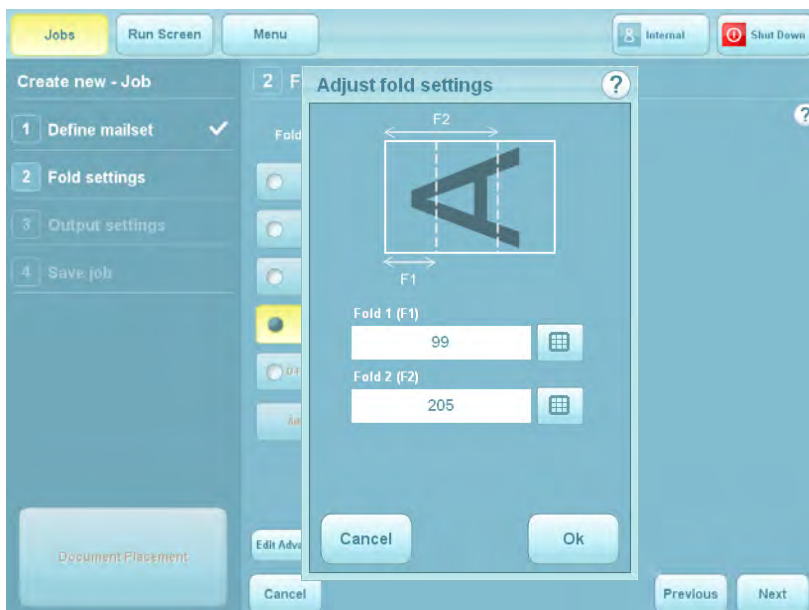

**19** Make adjustments as required and press the **OK** button.



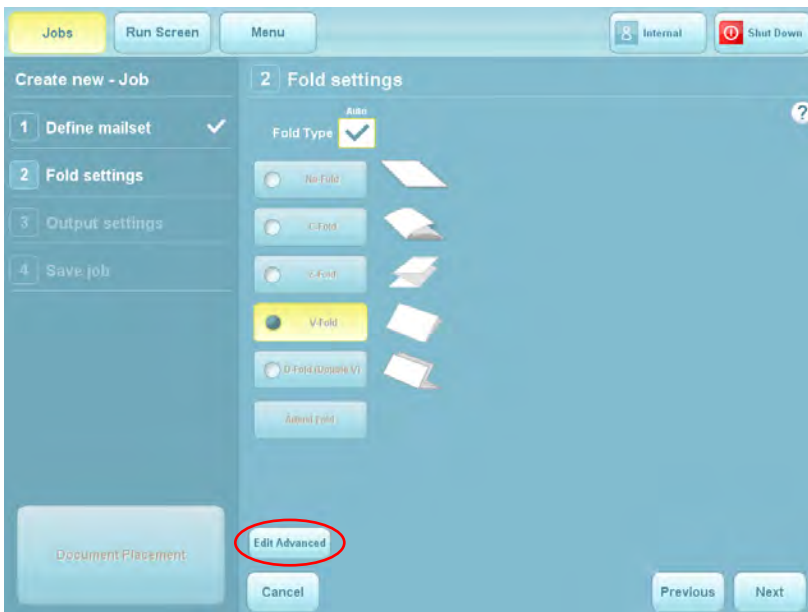

20 If you wish to make adjustments to the collation mode or Max no. of sheets folded together, press the **Edit advanced settings** button.

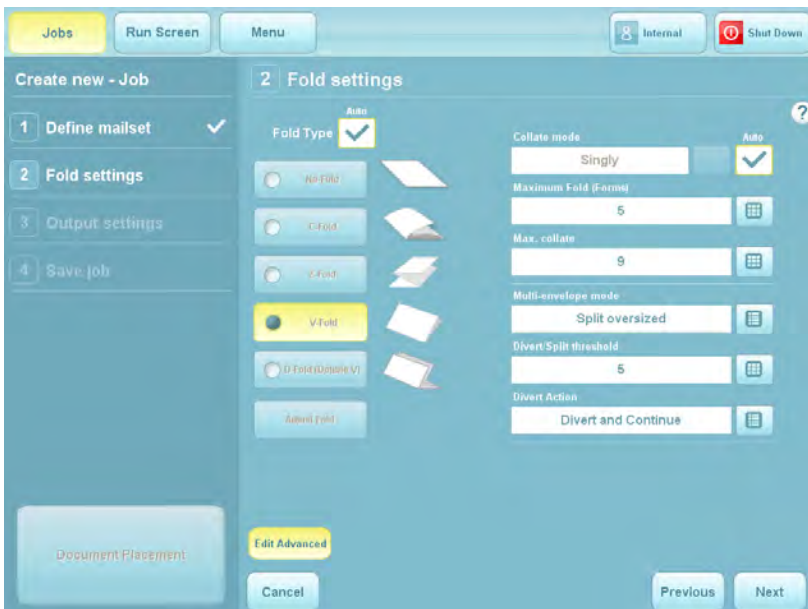

21 Choose whether to collate leading edges of documents as they feed through the folder, then folded together without entering the accumulator, or to feed separately into the accumulator before folding. Sheets are fed singly by default, so each sheet is folded and inserted separately. Set max number for folding together. Groups bigger than this will be split into a) max number, followed by b) remainder.

The maximum that can be fed into the accumulator defaults to 9, but can be up to 25. **Note:** This will depend upon the paper type.

Multi-envelope mode allows two separate jobs to be run in succession using the same document set. If set to 'Split Oversize', this splits, folds and inserts as for 'Max Fold' described above. If set to 'Divert Oversize', all groups numbering greater than the number set in 'Divert/Split Threshold' will be diverted to the divert tray, and if set to 'Divert Undersize', the same will apply for groups below the threshold.

The machine is then stopped, the job is changed and the forms in the divert tray are put back into the document set, and the new job is run.

'Divert Action' allows the option of the machine stopping automatically upon divert, or to continue, allowing the operator to intervene.

When you have finished, fold settings are now complete and the screen will show that this is ticked. **You will now define the output settings.**

### 7.1.3 Defining the output settings

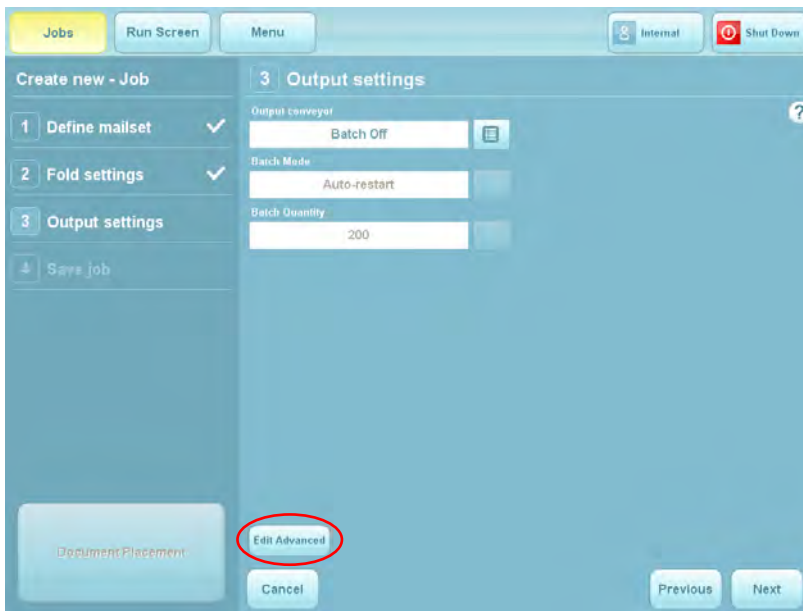

22 Select whether batch mode is to be used, and the quantity. The machine will then process this number of cycles, then stop. This will be repeated until the machine is stopped.

To define the batch jog steps, franker and MPPC modes, press the **Edit advanced settings** button.

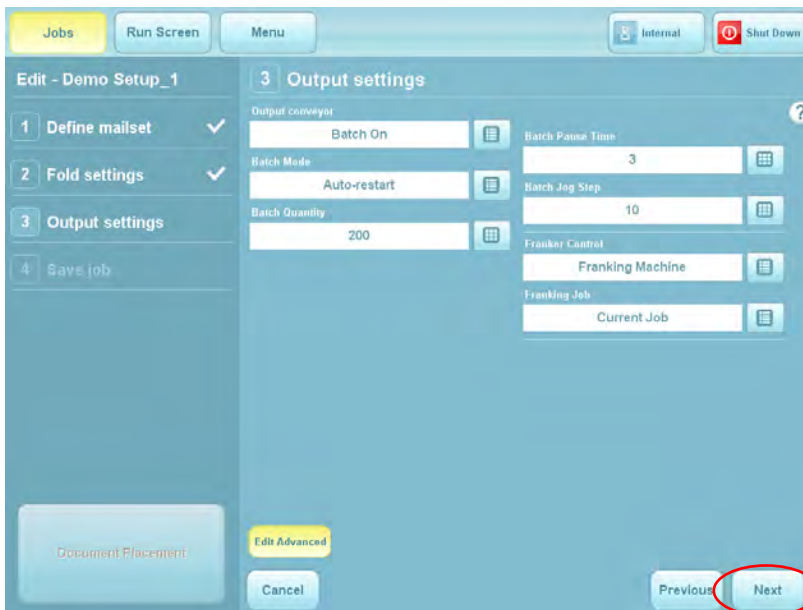

23 Select batch jog steps and pause time. This means that as each batch is fed onto the conveyor, it will move the specified amount (the steps are unitless), and pause for the specified time.

The franking machine mode and job are described on the following page.

## Mode Options

- **Not Used:** The franking conveyor will be driven like a standard conveyor, pulsed on each envelope.
- **Dumb:** The franking conveyor will be run continuously while the inserter is running.
- **Pass-through:** Level 2/3 function – envelopes will not be franked.
- **Franking Machine:** Level 2/3 function – envelopes will be franked according to the program settings in the franking machine.

## Job Options

- **Current Job:** Run the currently selected job 'as-is'.



For most purposes, **Mode** will be set to 'Franking Machine' and **Job** will be set to 'Current Job'.

---

The output settings are now defined, and the screen will show that this is ticked.

**You will now save the job.**

#### 7.1.4 Saving the job

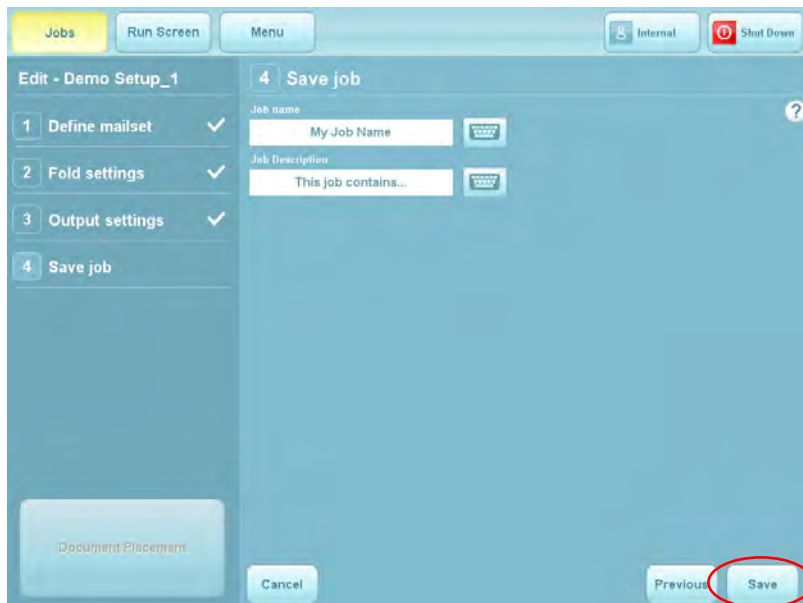

**24** Press the keyboard icon to display the virtual keyboard.

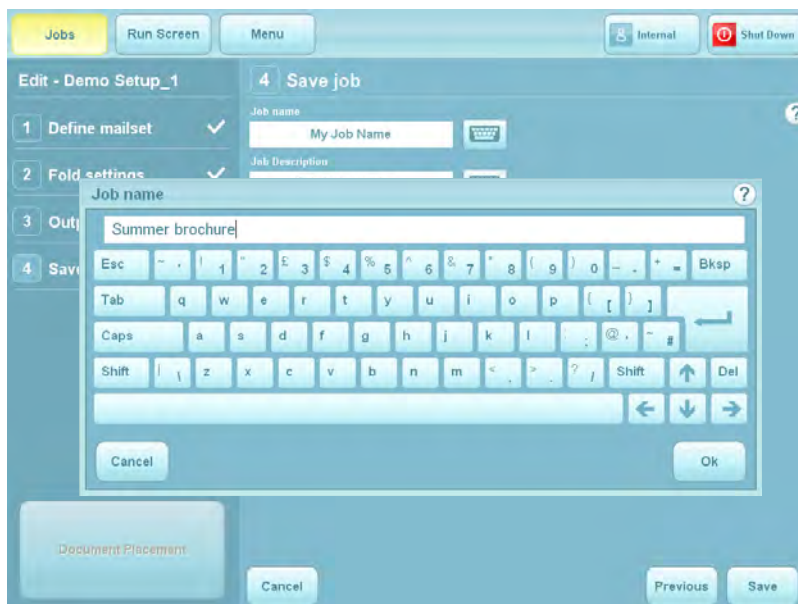

**25** Enter a name for the job using either the virtual or physical keyboard.

Repeat steps 26 & 27 to enter a brief description for the job. This is the description that will appear in the job list when the machine is started.

**26** Enter a name for the job using either the virtual or physical keyboard.

**You have now successfully created a new job and it will appear in the job list.**

## 7.2 Creating an envelope

In order for an envelope to appear in the envelope library, it must first be created.

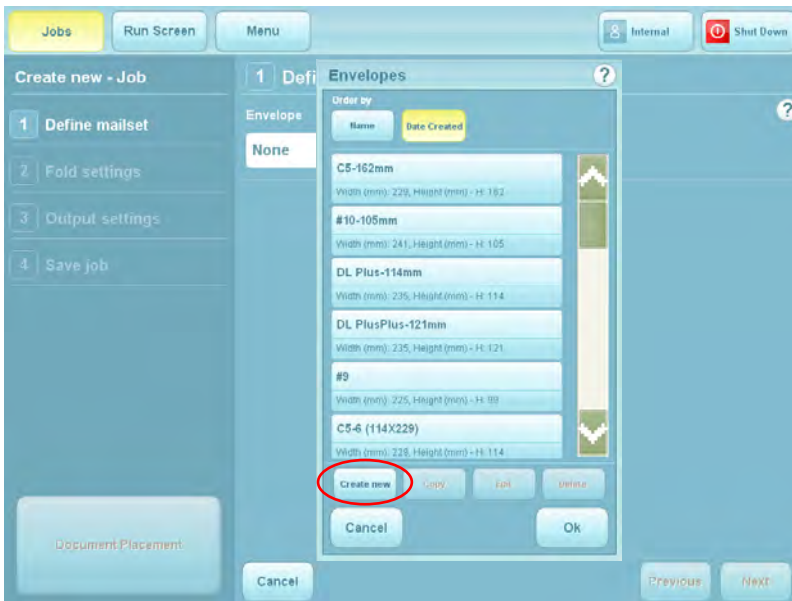

1 Begin creating a job (see section 7.1)

2 At the point where you need to select an envelope, press the **Create** button.

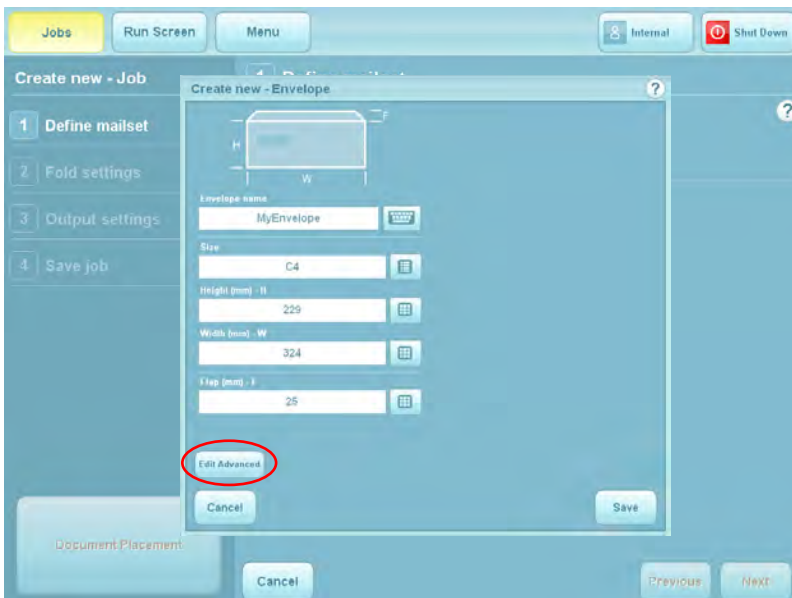

3 Enter a name for the envelope: press the virtual keyboard icon and enter the name using either the physical or virtual keyboard.

Select an envelope type. The default width and height for that type will then be shown. If you want to adjust the size, the type will change to 'Custom'.

If you want to adjust the envelope weight and flap depth, press the **Edit Advanced** button.

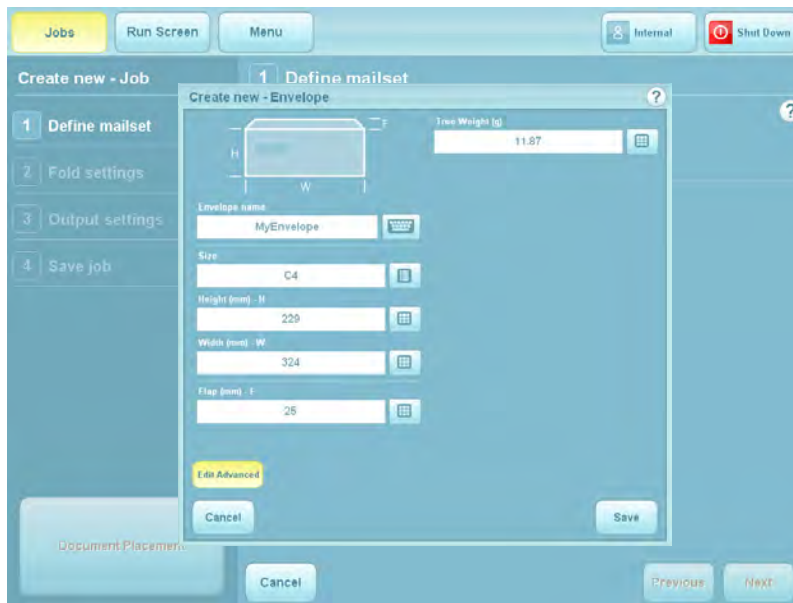

4 Adjust the weight as required. Note that the weight is the actual weight of the envelope, not the paper weight.

Press the Save button when done.

The envelope will now be available in the envelope library under the name you have given it.

**The envelope is now fully defined and is available for use.**

## 7.3 Creating a document

In order for a document to appear in the document library, it must first be created.

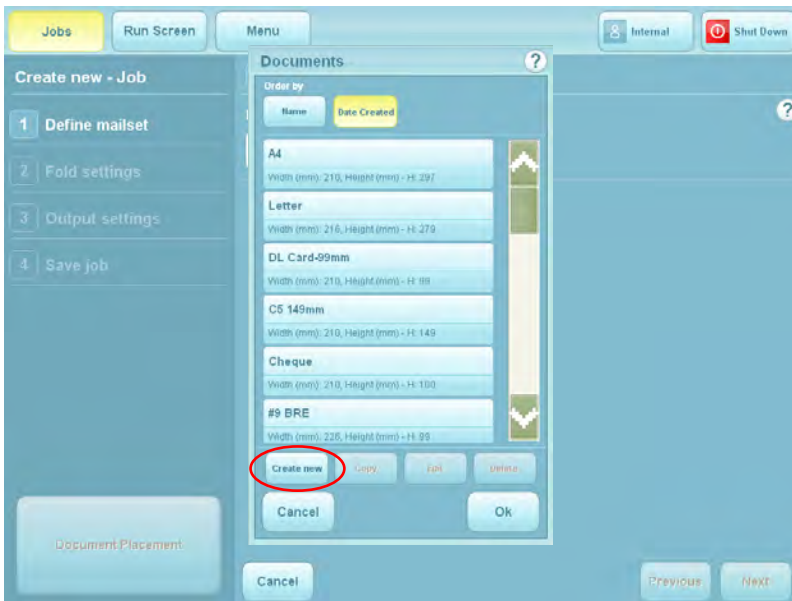

1 Begin creating a job (see section 7.1).

2 At the point where you need to select a document, press the **Create** button.

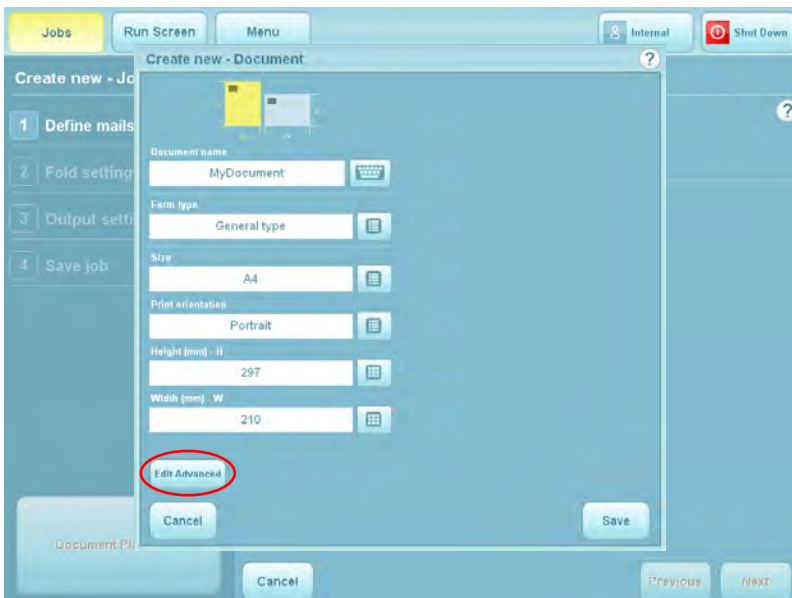

3 Enter a name for the document: press the virtual keyboard icon and enter the name using either the physical or virtual keyboard.

Select a document type and size. The default width and height for that type will then be shown. If you want to adjust the size, the type will change to 'Custom'.

If you want to make further adjustments, or select a reading definition, press the **Edit Advanced** button.

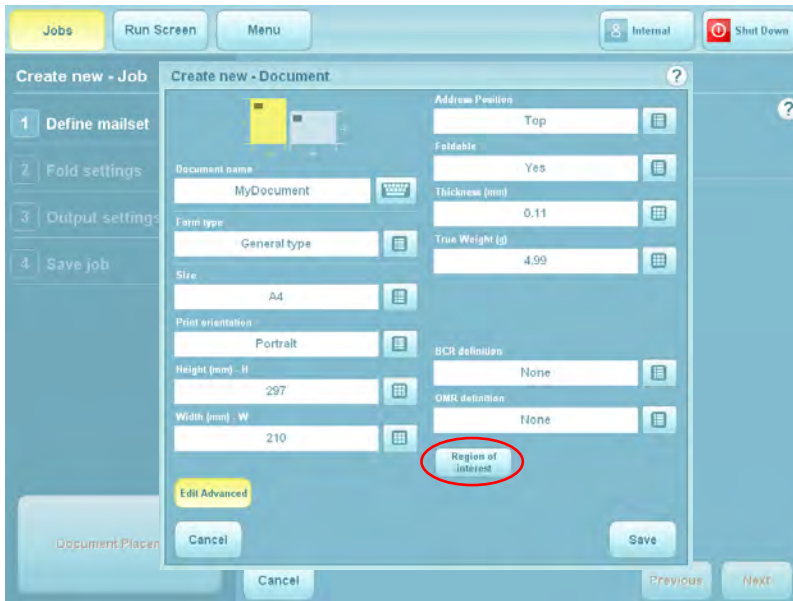

4 Select the address position. This defaults to 'Top'; specify middle, bottom or none if required.

Specify whether the document is to be folded (eg. a booklet would not be) and its thickness and weight. Note this is the actual weight of the document, not the paper weight.

The thickness is more applicable to booklets - if no figure is specified, 80gsm paper will be assumed.

If the document uses an OMR or barcode label, select a reading definition. **Note: this is obtained under licence as an option and must already exist on the machine.**

If the document does not use an OMR or barcode label, press the Save button, otherwise, proceed as follows.

5 Press the **Region of Interest** button to specify the position of the label.

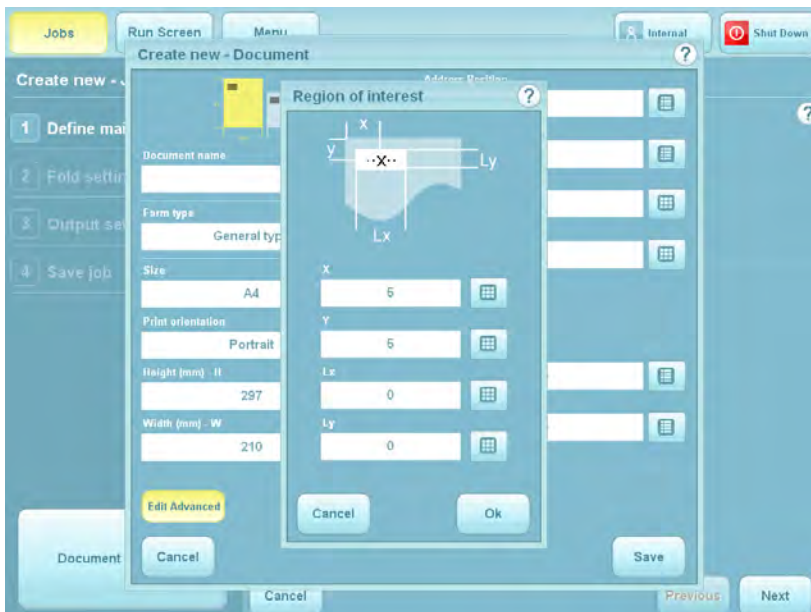

6 Specify the position of the label and press the **Save** button when done.

**The document is now fully defined and is available for use.**



## 7.4 Creating an enclosure

In order for an enclosure to appear in the enclosure library, it must first be created.

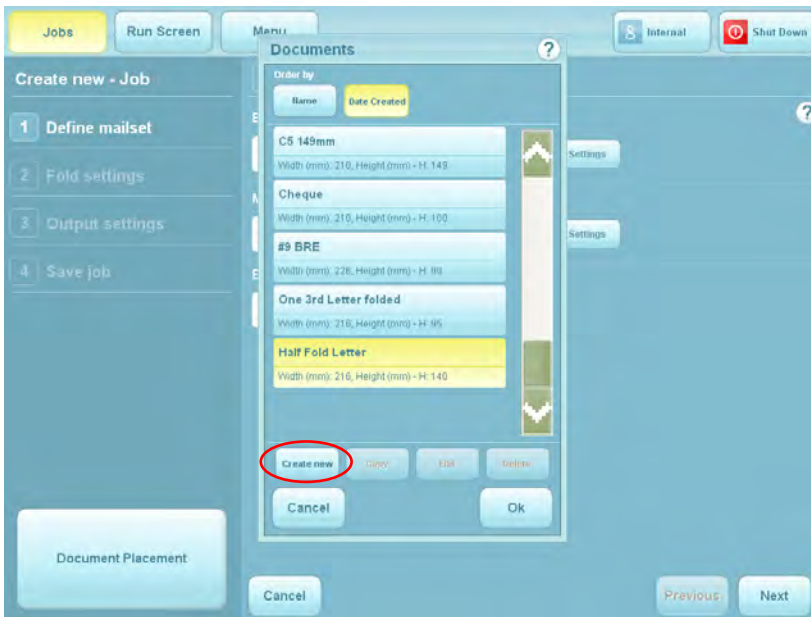

**1** Begin creating a job (see section 7.1).

**2** At the point where you need to select an enclosure, press the **Create** button.

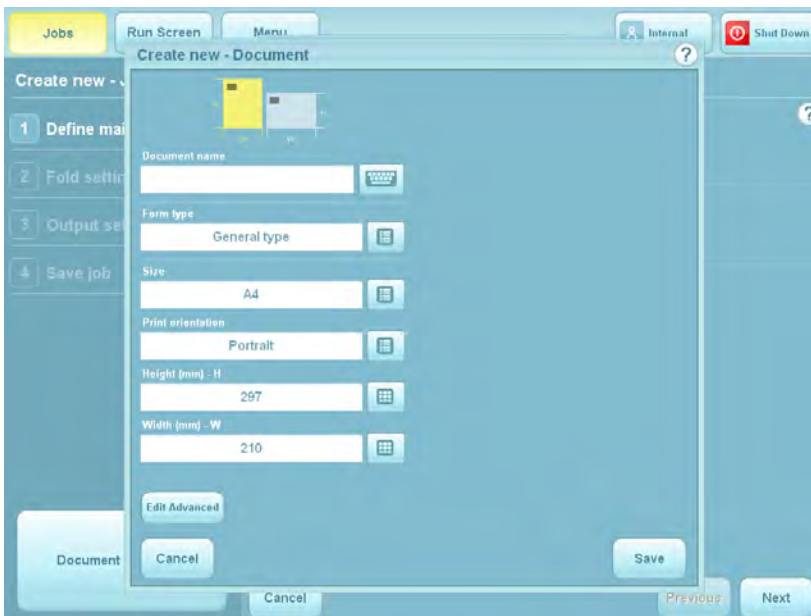

**3** The procedure for defining an enclosure is the same as that for a document, described in section 7.3. It is the document *type* that you select that determines whether it appears in the document or enclosure library.

**See section 7.3 for the remainder of the settings.**

**The enclosure is now fully defined and is available for use.**

## 8 Loading the paper hoppers

### 8.1 Loading the envelope hopper

Using the black knob, adjust the side guide to give 1-1.5mm clearance each side of the envelope.

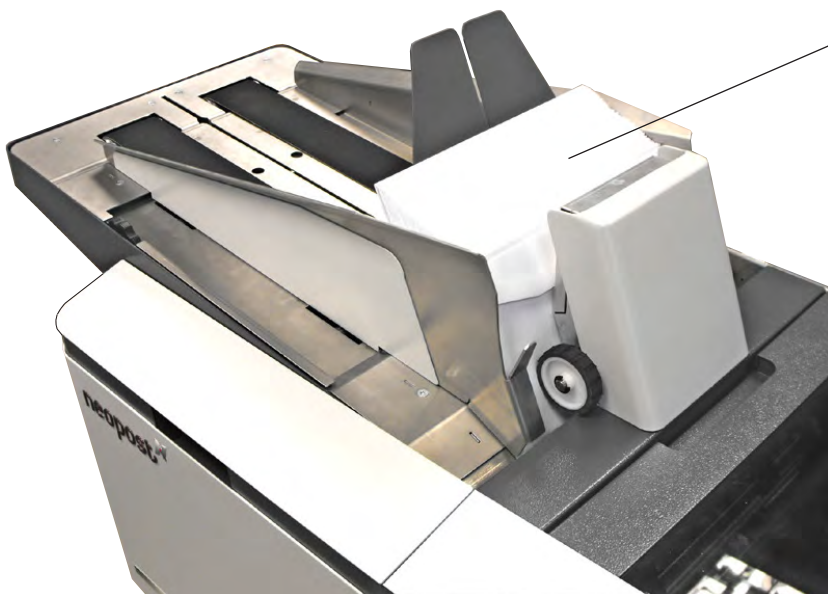
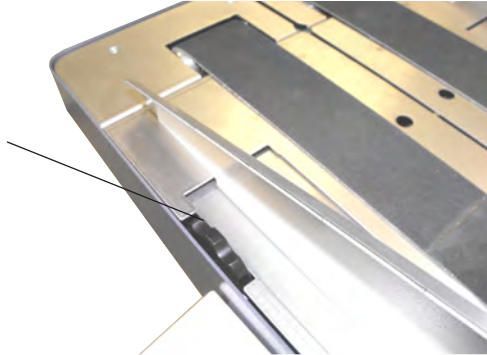

Adjust the angle of the backrest (see below) and load the envelopes into the hopper, flaps forward so that the lower edges follow the contour of the surface and down into the pick-up roller. Move the backrest forward (see below) so the envelopes are fully packed forward, but not tightly packed.

Move the backrest forward by squeezing the roller bar upwards to release the rollers from the track.

Adjust the angle by slackening the knob each side.

C4: Fully raised

DL/DL+: Fully lowered

#### **Note:**

If the envelopes feed erratically, try a backrest angle in-between.

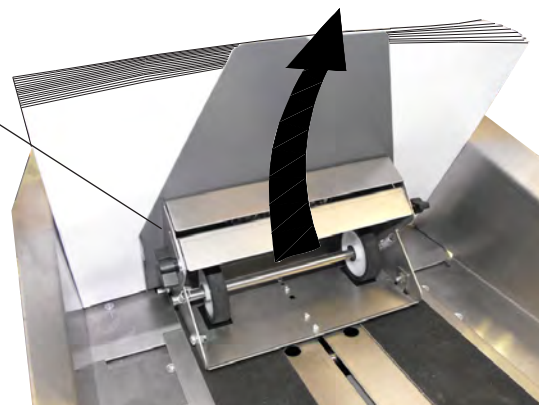

## 8.2 Loading the versatile feeder hopper

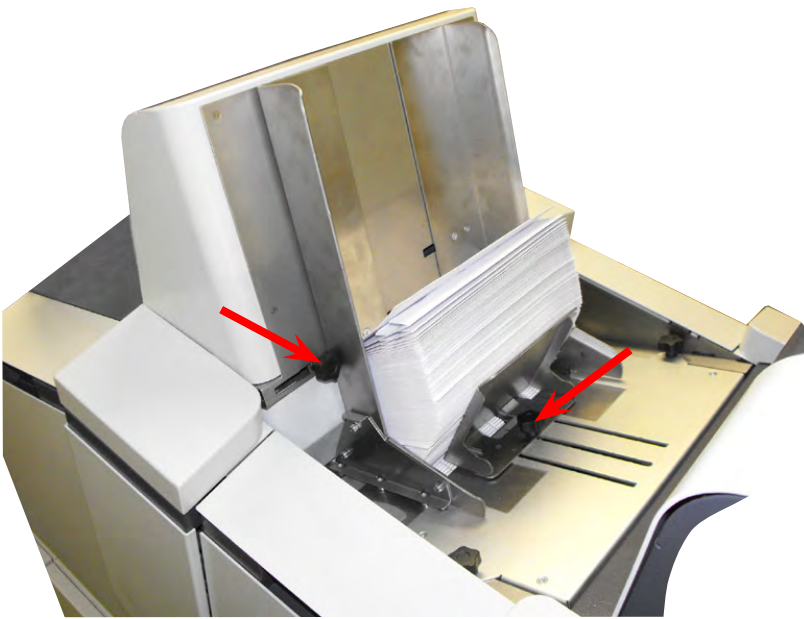

1. Slacken the black knob next to the side guides (arrowed) and move the guides to give 1-1.5mm clearance each side of the enclosure. Tighten the knob.

2. Slacken the black knob under the backrest (arrowed) and move it forwards to support the enclosures as shown. Ensure the enclosures are directed down into the feed rollers. Tighten the knob.

### Adjusting the separator

The separator prevents more than one enclosure being fed at a time.

To adjust the separator, turn the knob on the back of the feed hopper. Clockwise decreases the gap, anti-clockwise increases it. To set the separator gap, empty the hopper, then slide an enclosure into the gap and turn the knob until the separator will just grip the enclosure as you withdraw it.

To help you establish an initial setting, there is a setting gauge on the separator unit, visible after opening the feeder side cover. See following page.



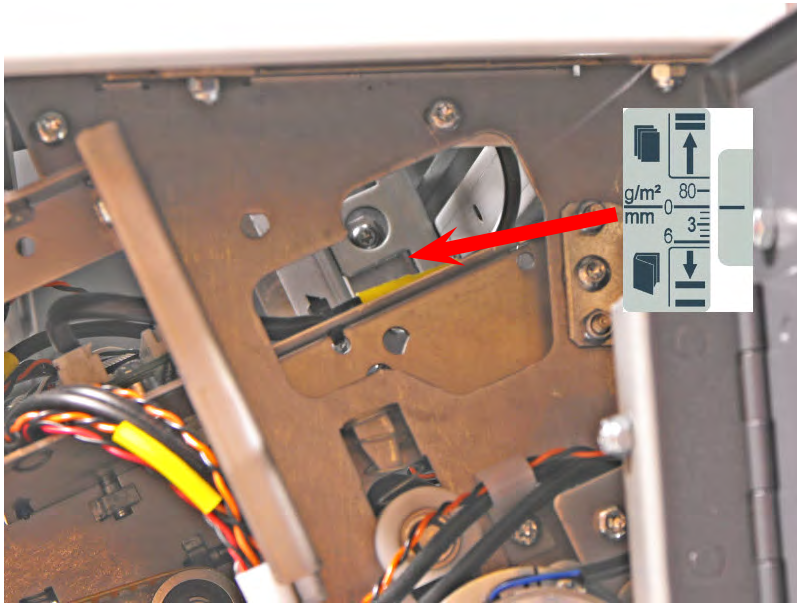

1. Look into the aperture shown and you will see the setting gauge on the side of the separator unit. There is an 80gsm mark as a starting point for single sheets, and mm settings underneath the 0 line for booklets etc. **See also section 8.5 'Daily Post'**.

2. Now adjust the gap as previously described to set it precisely.



For problem enclosures, the feed rollers can be changed to optional alternatives; see section 9.3



See following page for load capacities of different stationery types. **Note:** these are a guideline only - actual quantities may vary. The label on the side guide will also provide an indication.

**1000 Sheets of 80gsm (20lbs bond) or 400 BRE (DL)**



**130 x 2.5mm A5 Booklets**

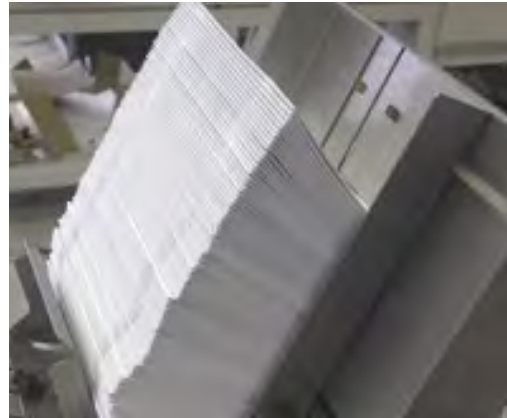

**40 x 6mm A4 Booklets**



**500 x 0.5mm A5 Booklets**

### 8.3 Loading the flex folder hoppers

The flex folder may be fitted with 500-sheet or 1000-sheet hoppers, or only a single 500-sheet hopper. The example shown has 2 x 500-sheet and 1 x 1000-sheet hoppers.

1. On 500-sheet hoppers, slacken the black knob next to the side guides (arrowed) and move the guides to give 1-1.5mm clearance each side.

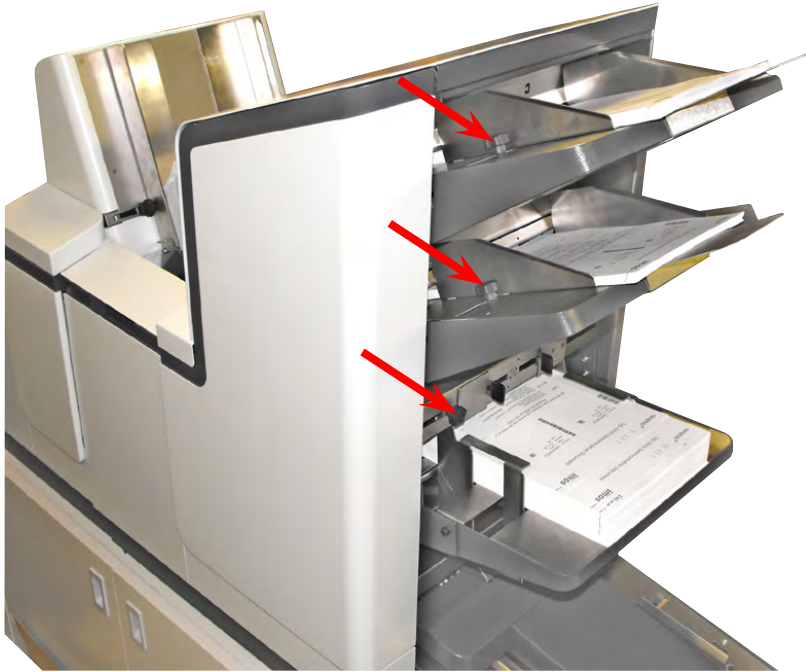

On 1000-sheet hoppers, slacken the black knob above the hopper (arrowed) and use the tabs to move the guides to give 1-1.5mm clearance each side.

2. Tighten the knobs.



Paper orientation in the hoppers will depend upon the job requirement - see the paper orientation charts on page 50.

### Accumulator

If the flex folder is fitted with an optional accumulator, the side guides must be adjusted to suit the paper.

Raise the top of the accumulator so that it locks in place and place a piece of paper between the side guides.

Slacken the black knob next to the side guides (arrowed) and move the guides to give 1-1.5mm clearance each side.

Actuate the latch (arrowed) to lower the accumulator top.



## Fold Plate 2

If fold-plate 2 is being used in the folding operation, it must be adjusted as shown below (see chart on the following page for guide on fold plate usage).

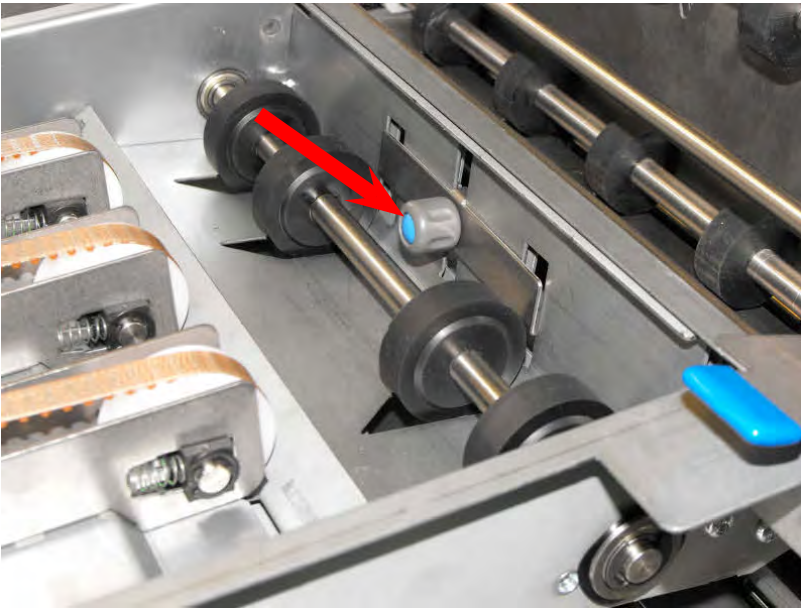

1. Open the side cover on the flex folder. Slacken the fold plate knob indicated and adjust it according to the length setting on the scale.
2. Tighten the knob.

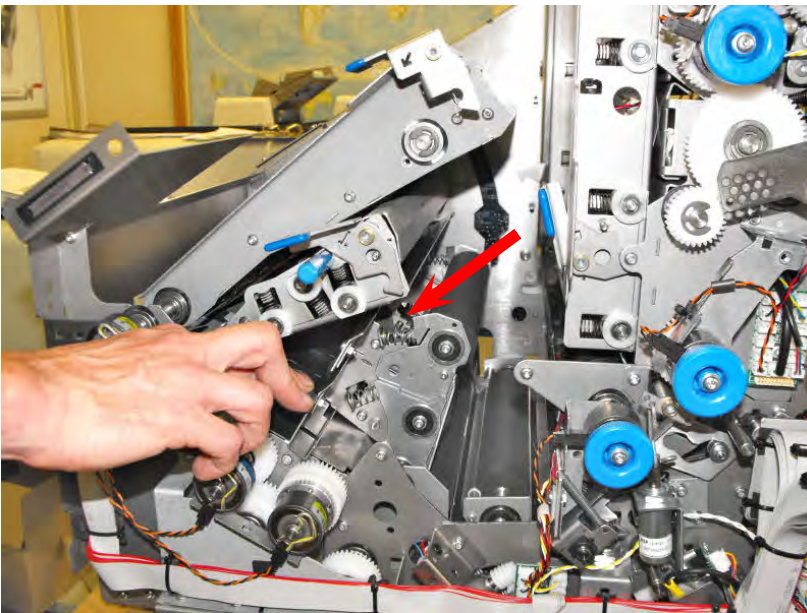

3. Raise the two transport assemblies so that they latch in place, and lift the roller assembly below them.
4. Slide the indicated latch away from you. This will open fold plate 2 for use (most applications do not use fold plate 2).
5. Lower the roller and transport assemblies, ensuring they are latched in place.



# Paper Orientations

Paper orientations for various applications are shown below.

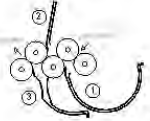
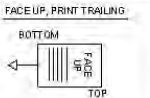
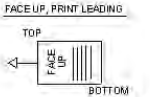
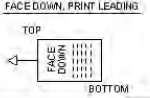
European Sizes:

D16403 Tower Fold Configurations			Form Input Orientation			Fold Panel Lengths			
UK & European Sizes			Face Down Head First	Face Down Feet First	Face Up Feet First	Fold Plate 1	Fold Plate 2	Fold Plate 3	
Job Code	Job Description	Fold Type							
CF1	A4 Form (297mm x 210mm) Document printed with <b>top</b> address	'C' Fold	✓			68mm (121mm long envelope) 90mm (110mm long envelope)		115mm (121mm long envelope) 104mm (110mm long envelope)	  
CF2	A4 Form (297mm x 210mm) Document printed with <b>middle</b> address	'C' Fold	✓			163mm (121mm long envelope) 194mm (110mm long envelope)	115mm (121mm long envelope) 104mm (110mm long envelope)		
CF3	A4 Form (297mm x 210mm) Document printed with <b>bottom</b> address. Address upside down in window	'C' Fold		✓		68mm (121mm long envelope) 90mm (110mm long envelope)		115mm (121mm long envelope) 104mm (110mm long envelope)	
ZF1	A4 Form (297mm x 210mm) Document printed with <b>top</b> address	'Z' Fold			✓	229mm (121mm long envelope) 207mm (110mm long envelope)		115mm (121mm long envelope) 104mm (110mm long envelope)	
ZF2	A4 Form (297mm x 210mm) Document printed with <b>top</b> address	'Z' Fold	✓				68mm (121mm long envelope) 90mm (110mm long envelope)	115mm (121mm long envelope) 104mm (110mm long envelope)	
ZF3	A4 Form (297mm x 210mm) Document printed with <b>bottom</b> address	'Z' Fold		✓		114mm (121mm long envelope) 103mm (110mm long envelope)	115mm (121mm long envelope) 104mm (110mm long envelope)		
VF1	A4 Form (297mm x 210mm) Document printed with <b>top</b> address	'V' Fold	✓			149mm			
VF2	A4 Form (297mm x 210mm) Document printed with <b>bottom</b> address. Address upside down in window	'V' Fold	✓			149mm			
DFP1	European 16" form (408mm x 210mm) Document printed with <b>top</b> address	Double Forward Fold	✓			177mm (121mm long envelope) 199mm (110mm long envelope)		115mm (121mm long envelope) 104mm (110mm long envelope)	
DFP2	European 16" form (408mm x 210mm) Document printed with <b>bottom</b> address. Address upside down in window	Double Forward Fold		✓		177mm (121mm long envelope) 199mm (110mm long envelope)		115mm (121mm long envelope) 104mm (110mm long envelope)	

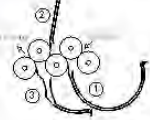
American Sizes:

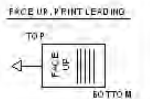
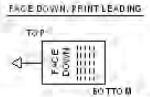
D16403 Tower Fold Configurations			Orientation in Hopper			Fold Panel Lengths			
American Sizes			Face Down Head First	Face Down Feet First	Face Up Feet First	Fold Plate 1	Fold Plate 2	Fold Plate 3	
Job Code	Job Description	Fold Type							
ACF1	US Letter format (11" x 8 1/2") Document printed with <b>top</b> address	'C' Fold	✓			82mm (#10 Envelope)		99mm (#10 Envelope)	  
ACF2	US Letter format (11" x 8 1/2") Document printed with <b>middle</b> address	'C' Fold	✓			81mm (#10 Envelope)	99mm (#10 Envelope)		
ACF3	US Letter format (11" x 8 1/2") Document printed with <b>bottom</b> address. Address upside down in window	'C' Fold		✓		82mm (#10 Envelope)		99mm (#10 Envelope)	
AZF1	US Letter format (11" x 8 1/2") Document printed with <b>top</b> address	'Z' Fold			✓	137mm (#10 Envelope)		99mm (#10 Envelope)	
AZF2	US Letter format (11" x 8 1/2") Document printed with <b>top</b> address	'Z' Fold	✓				82mm (#10 Envelope)	99mm (#10 Envelope)	
AZF3	US Letter format (11" x 8 1/2") Document printed with <b>bottom</b> address	'Z' Fold		✓		98mm (#10 Envelope)	99mm (#10 Envelope)		
AVF1	US Letter format (11" x 8 1/2") Document printed with <b>top</b> address	'V' Fold	✓			140mm			
AVF2	US Letter format (11" x 8 1/2") Document printed with <b>bottom</b> address. Address upside down in window	'V' Fold	✓			140mm			
ADFF1	US Legal format (14" x 8 1/2") Document printed with <b>top</b> address	Double Forward Fold	✓			197mm (#10 Envelope)		99mm (#10 Envelope)	
ADFF2	US Legal format (14" x 8 1/2") Document printed with <b>bottom</b> address. Address upside down in window	Double Forward Fold		✓		197mm (#10 Envelope)		99mm (#10 Envelope)	



## 8.4 Paper Control Lever

The paper control lever is located in the collate area, and raises or lowers overguide strips in the paper path. For normal running, the overguide strips should be lowered to assist paper movement. However, in some cases (such as a single lightweight sheet, or a thick pack with a lightweight prime document on top), it may assist paper movement to raise the overguide strips.

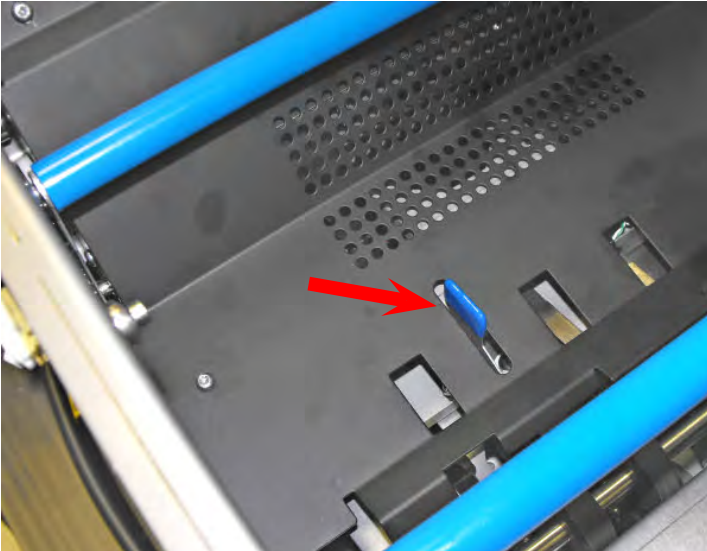

1. Raise the perspex top cover to obtain access to the collate area.
2. Move the lever rearwards (ie. away from the envelope feeder) for normal running.
3. Move the lever forwards (ie. towards the envelope feeder) for single sheets, lightweight prime documents etc.
4. Lower the perspex top cover.

## 8.5 Daily Mail (Handfeed)

Daily post allows a group of forms to be hand-fed, folded and inserted on a Versatile Feeder. A group of forms up to a total of 6mm thick may be fed, but be aware of the folding capacity of 8 forms of 80gsm (20lbs bond). The forms may be stapled or not, as required (see below for stapling restrictions).

### 8.5.1 Stapling Restrictions

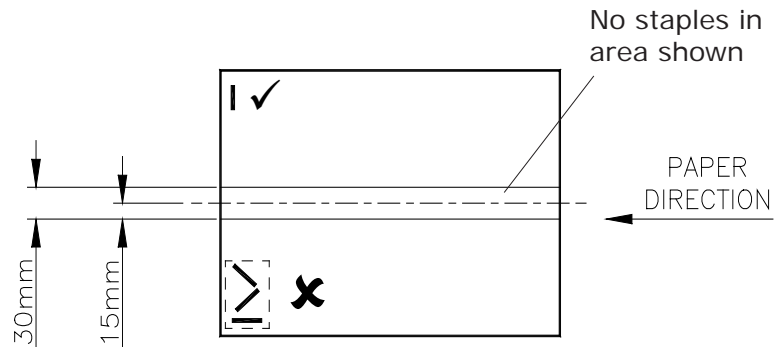

### 8.5.2 Using Daily Mail

To use daily mail, define a new mailset (as described in section 7.1.1) or edit the document settings in an existing job.

Select **Settings** for the document and set 'Daily Mail' to **Yes**.

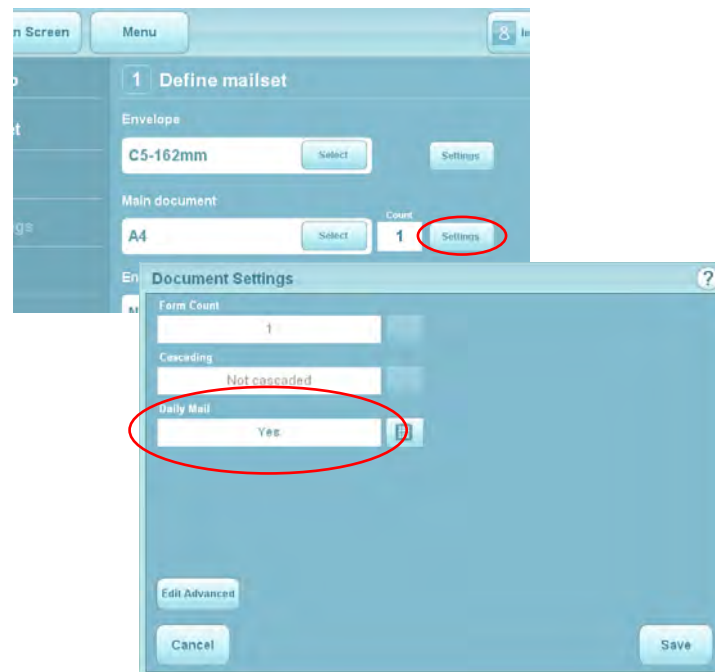

Save the document settings, then press **Next** until you reach the **Save** button to save the job.

cont.

### 8.5.3 Setting the Separator Gap (see also section 8.2 'Adjusting the Separator').

Now set the separator gap to suit the daily mail. As a general guide, the gap should be set to approx. 1mm greater than the pack or booklet thickness. If the document is an 80gsm sheet, set the gap to 1mm.

If the thickness is unknown, proceed as follows:

- Open the separator gap wide enough to allow the document to pass through. Insert a corner of the document between the separator wheels as shown - this avoids snagging the grooves in the tyres (particularly useful for thin documents).
- Close the separator gap until there is some friction on the document, then rotate the separator knob in reverse direction 1 turn (this will give clearance of 1mm).



When daily mail has been enabled as described, and the gap has been set, press the **Run** button and feed the post into the hopper tray. The machine will wait for 30 seconds after pressing the button - if you exceed this before inserting the documents, press the button again.

To turn the function off, switch 'Daily Mail' back to **No** in Document Settings.

### 9.1 Cleaning the sensors

The optical sensors consist of two halves: emitter and receiver. These can become obstructed due to paper dust and should periodically be cleaned using a non-flammable airduster. Both halves must be cleaned.

This section shows where the sensors are located. For most sensors, an indicator arrow is pierced showing you where the jet of the airduster should be directed. For some sensors, the retaining bush is visible next to the lens: ensure you spray into the lens, not the bush.

Insertion head



Sensors are retained with a bush next to the lens: where this is visible, ensure that you spray into the lens (arrowed), not the bush.

Direct the airduster into the openings arrowed and spray liberally.

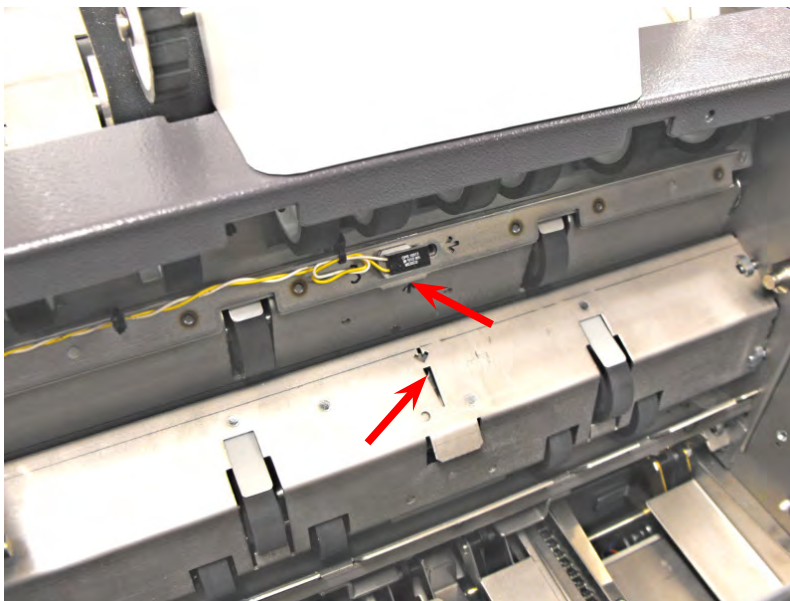

Open the perspex top cover and raise the collate clamshell (closest to the envelope hopper) so that it locks in place.

Picture shown is viewed looking inside the collation area towards the envelope hopper.

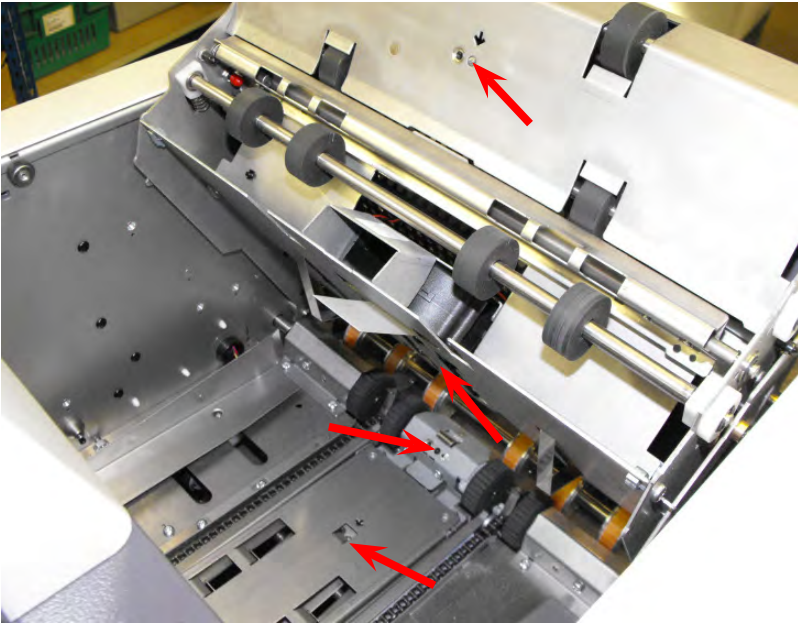

Picture is viewed looking inside the collation area away from the envelope hopper.

Clean all sensors arrowed.

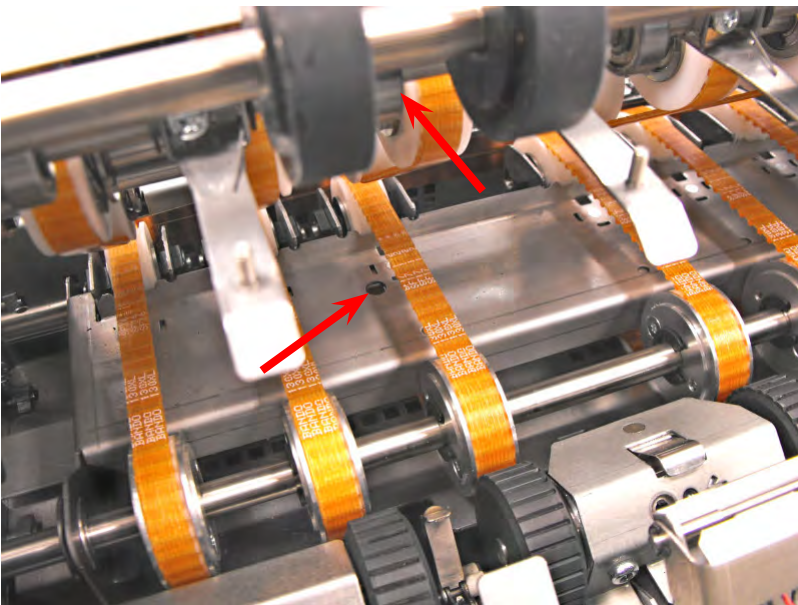

Lower the collate clamshell and open the upper conveyor (furthest from the envelope hopper) so that it locks in place.

Picture is viewed looking inside the collation area away from the envelope hopper.

Insert the airduster nozzle deep into the hole and spray liberally. Note the the upper sensor half is not easy to see and is mounted on a bar.

Lower the conveyor.

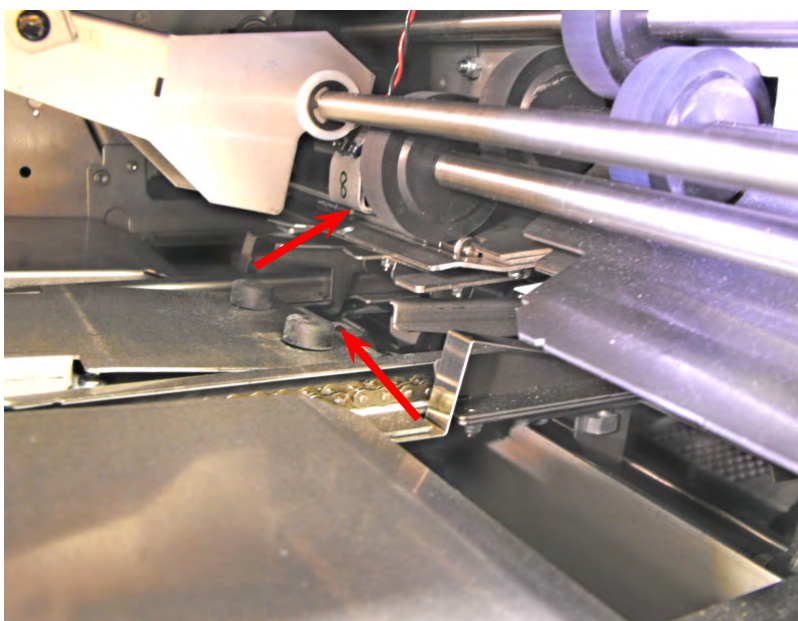

Lower the side cover and raise the overguide inside the closer cavity, latching it in place.

Clean the sensors arrowed.

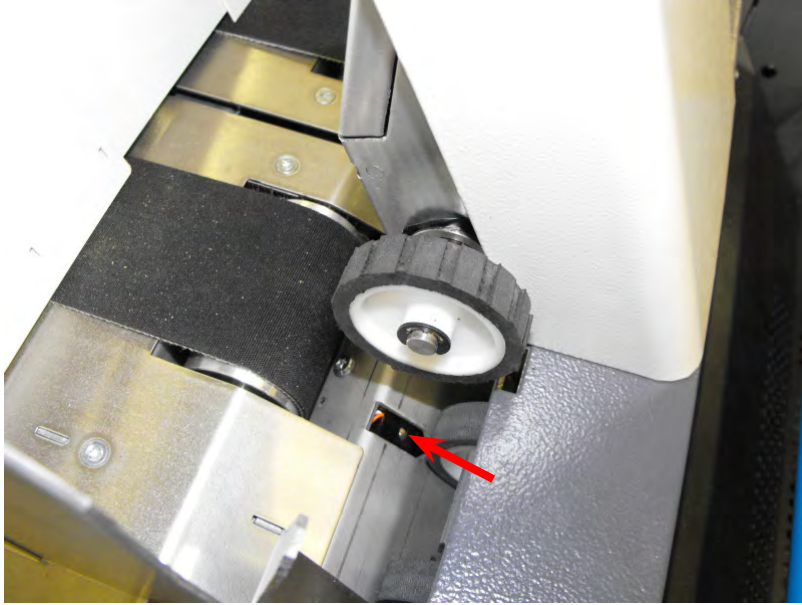

Picture is viewed looking down on the envelope hopper, at the front.  
Clean the one-piece reflective sensor.

## Versatile Feeder

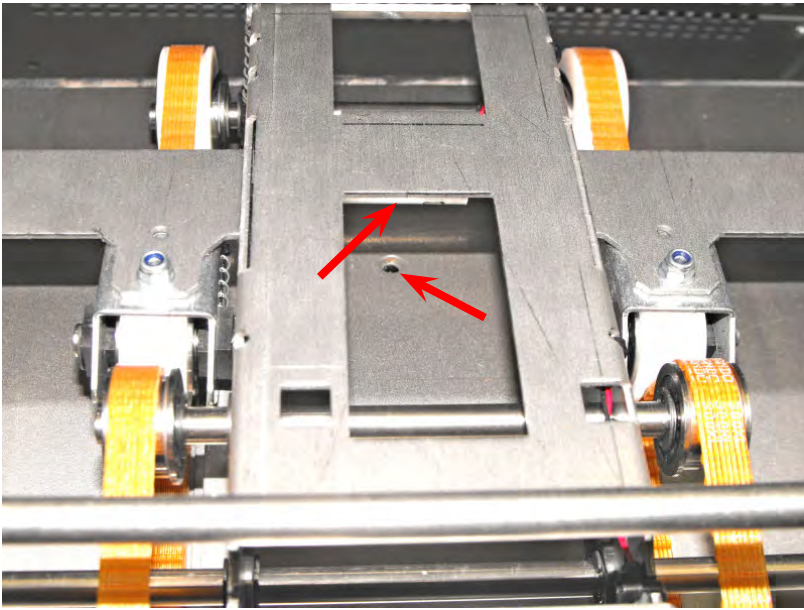

Open the feeder top covers at the front, if the feeder is the first station. If a subsequent station, open the side cover and approach from the side.

Picture is viewed looking towards the front.

Clean the sensor arrowed. The upper half is located on a bracket above the lower half.

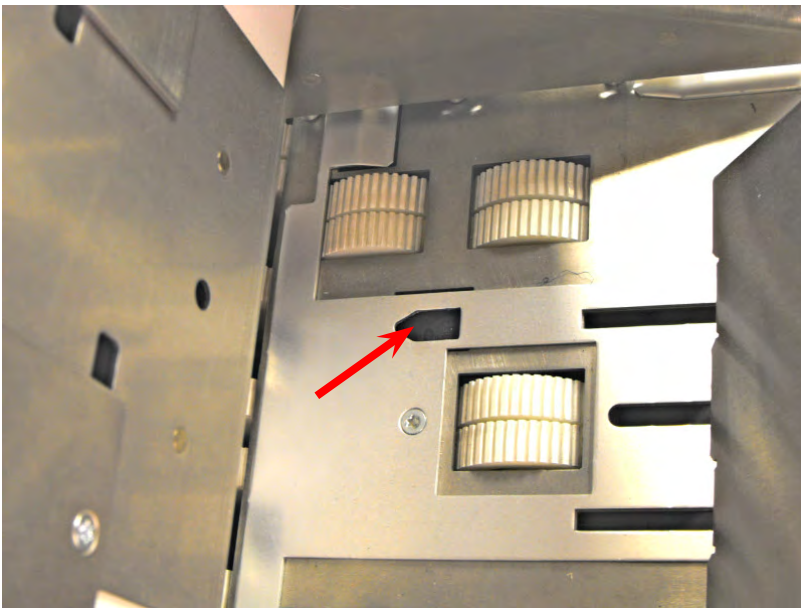

Open the feeder top covers at the front. Picture is viewed from the side.

Clean the one-piece reflective sensor.

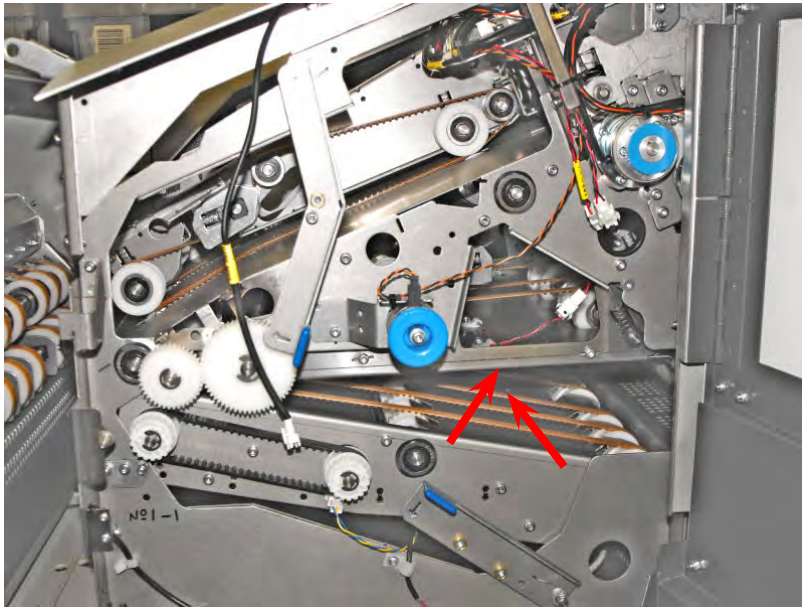

Open the side cover and push the lowermost lever forward to lower the conveyor.

Clean the sensor located in the centre of the track as shown, with the upper half directly above it.



## Flex Folder

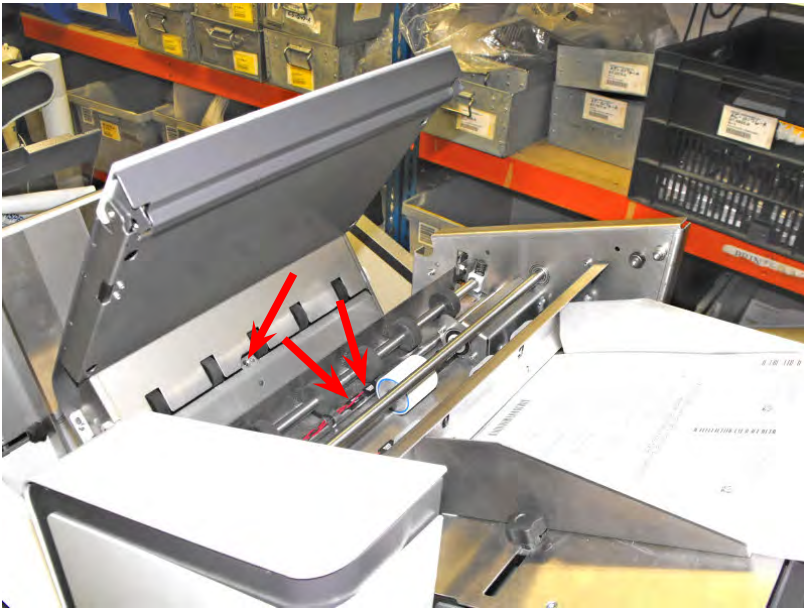

Open the folder top cover and clean the sensors indicated.

For the two sensors shown side-by-side, direct the nozzle of the airduster into the gap at the front of the them and spray liberally.

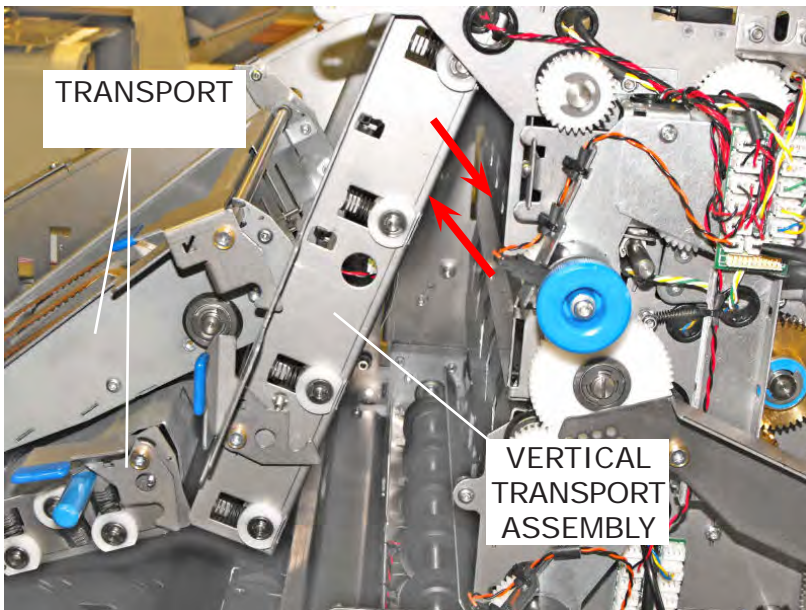

Open the side cover and raise the two transport assemblies so that they latch.

Swing forward the vertical transport assembly and clean the sensor halves indicated. Note: these are not easy to see, and a separate light such as a torch may help.

When returning the transport assemblies, ensure that they latch back into place properly.

## 9.2 Clearing paper jams

If paper jams occur, the area affected will normally be shown in the error message on the screen. Use one of the clearance methods described below to clear the jammed paper.

**Inserter head**

Open the side cover on the operator side of the machine.

**Versatile Feeder**

Open the side cover on the versatile feeder.

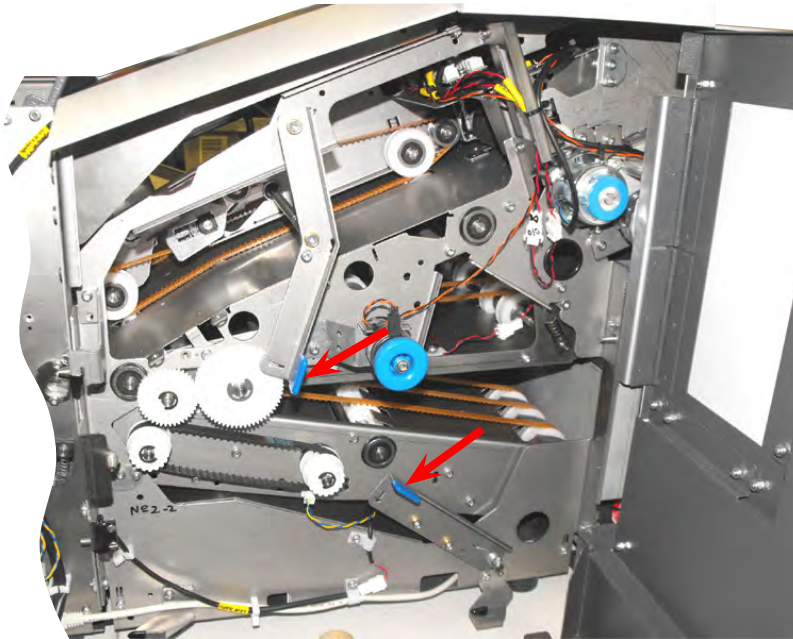

Push forward the levers indicated to open the cavities and access the jammed paper.

If the paper is not fully visible, turn the blue knobs to wind it into view.

**Flex Folder**

Open the side cover on the flex folder.

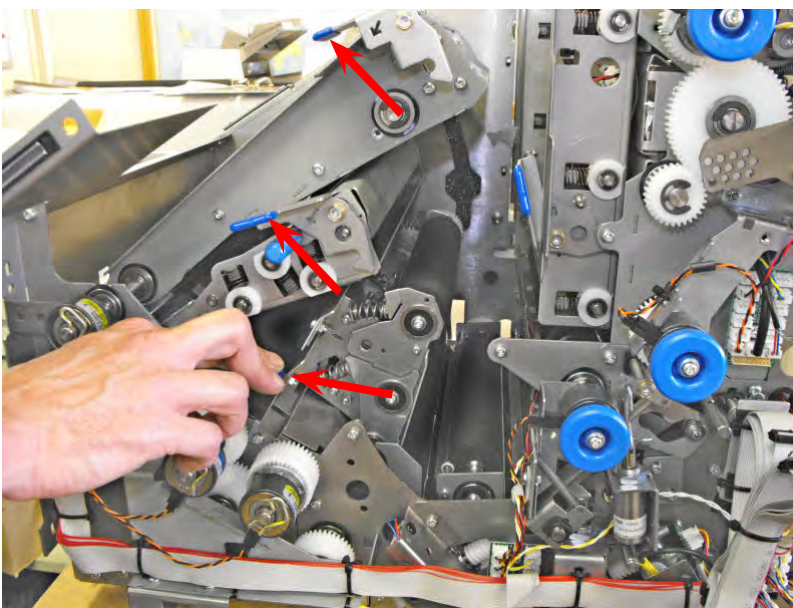

**Base Unit**

Using the release handles, raise the 2 upper plattens indicated and latch them in place. Raise the roller assembly below them to access the jammed paper. **Note:** the roller assembly does not latch in place.

If the paper is not fully visible, turn the blue knobs to wind it into view.

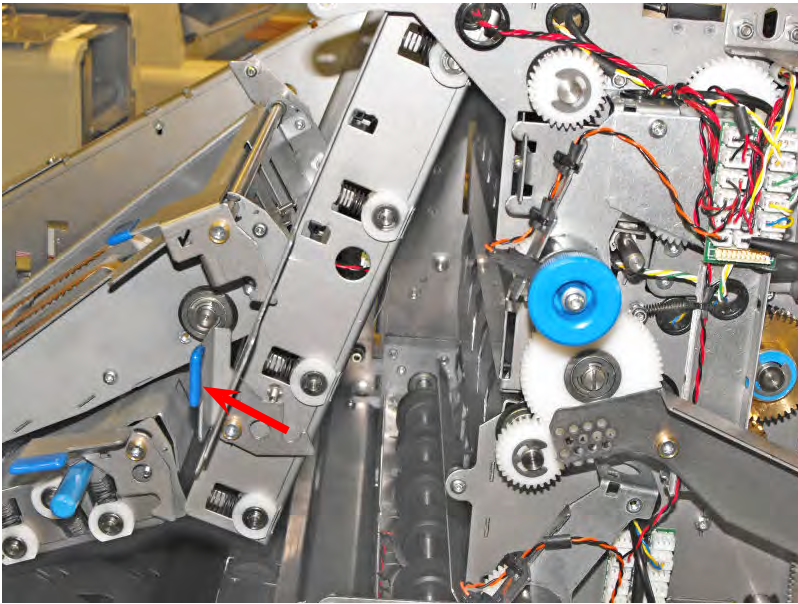

### **Tower Unit**

Using the release handle, swing open the vertical platten indicated and latch it in place. Raise the roller assembly below them to access the jammed paper. Note: the roller assembly does not latch in place.

If the paper is not fully visible, turn the blue knobs to wind it into view.

### 9.3 Changing the feed tires

Certain documents (eg. glossy materials) may not not feed properly with the standard feed rollers. Sets of optional feed tires are available to assist feeding. These can be fitted as follows.



Remove the 3 knobs indicated and open the side guides to their widest extent.

Lift the feed bed out of the chassis to access the feed shafts beneath.



Slide the spring-loaded collars inboard and lift the feed shafts out of their bearing hubs. The feed tires can be pried off the rollers and replaced with alternative items.

When replacing the shafts, ensure that the drive pins are properly located in the hubs.

## 9.4 Adjusting the CIS reader

If a CIS reader is fitted to a Flex Folder, it must be adjusted to align with the label, as described below

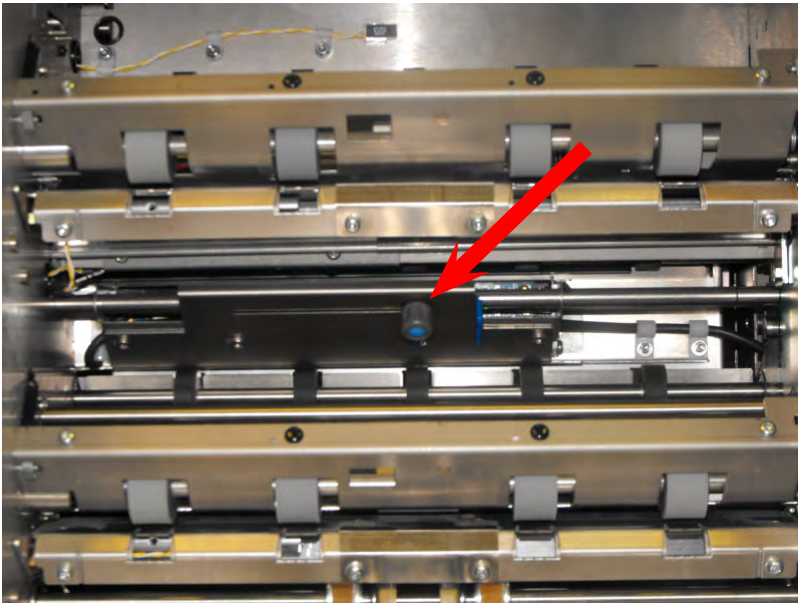

On a 500-sheet hopper pod, remove both feed trays to access the CIS reader as shown.

Slacken the knob and slide the reader as required, using the tabs. Tighten the knob.

**Note: the CIS reader should be moved fully left or right, depending upon which side of the paper the label is on.**

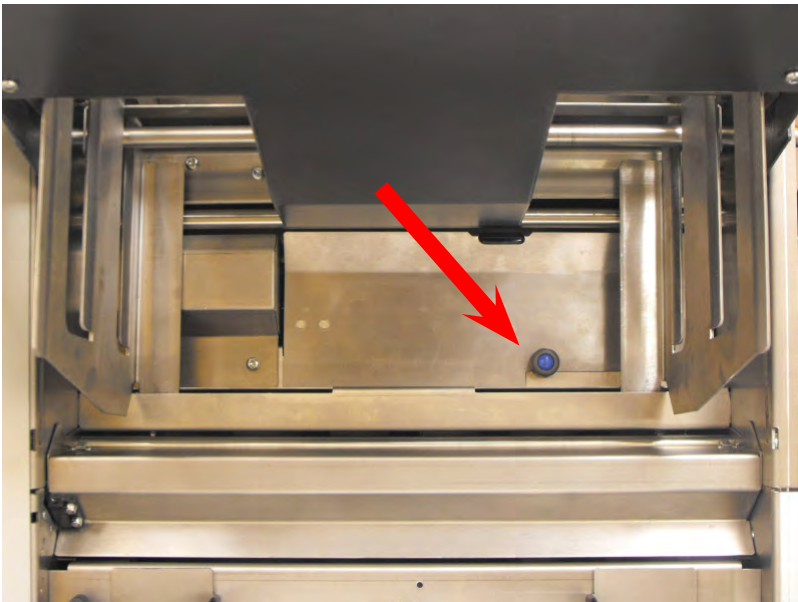

On a 1000-sheet hopper pod, remove all paper from the machine and operate a single cycle to raise the tray.

From below the tray, slacken the knob securing the cover as shown, and lift the cover out to access the CIS reader.

Adjust the reader as described above and replace the cover.

## 10 Technical Specification

### 10.1 Inserter head

**Pack thickness** Maximum pack thickness is defined as the internal dimension of a rigid opening that a filled envelope will fall through under its own weight.

#10 & DL Envelopes: up to 6mm (1/4")  
C5/C4 Envelopes and above: up to 6mm (1/4")

**Pack clearance** The minimum clearances required between the inserts and envelopes are dependent on insert pack thickness.

Clearance is the total clearance and is defined as the difference between the largest overall dimensions of the pack and the internal dimensions of the envelope (see below). The required clearances are summarised as follows:

Pack <3mm: Depth 6mm (1/4") Width 16mm (5/8")  
Pack >3mm <6mm: Depth 12mm (1/2") Width 19mm (3/4")

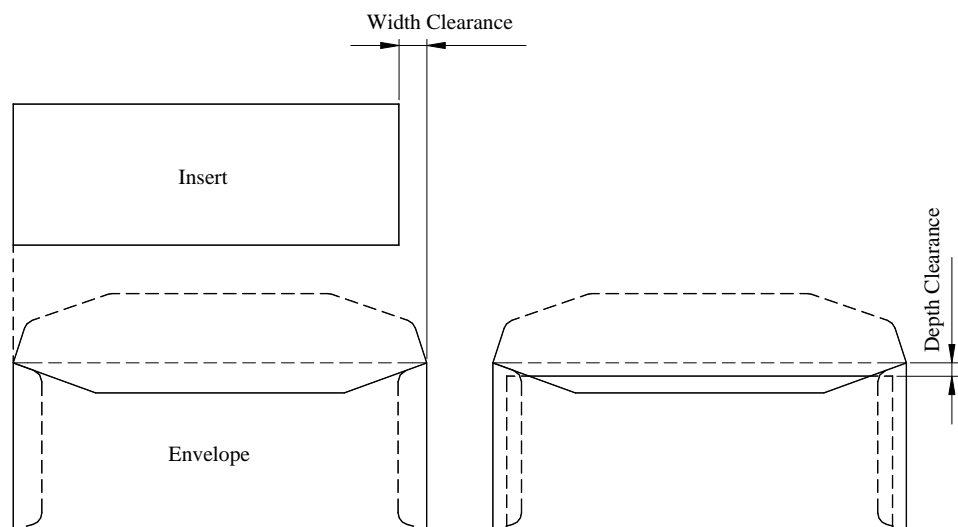

### Cycling speed

Up to 4800 envelopes per hour (based on 1 x A4 folded sheet into a C5/C65 or DL or #10 (114mm x 229mm) envelope).

Up to 3900 envelopes per hour (based on 1 x A4 folded sheet with 1 x enclosure into a C5/C6 or DL or #10 (114mm x 229mm) envelope).

Speeds for other conditions available on request.

<b>Monthly volume</b>	Up to 200,000 filled envelopes per month.
<b>Envelope Hopper capacity</b>	C5 or below - up to 800 of 90gsm (20lbs bond) C4 (flat type) - up to 100gsm (28lbs bond)
<b>Envelope weight</b>	Minimum: C5 or below - 70gsm (18lbs bond) Minimum: Above C5 - 90gsm (24lbs bond) Maximum: 110gsm (28lbs bond)
<b>General envelope requirements</b>	<ul style="list-style-type: none"> <li>• Envelope to be good quality machine-fill type. Dimensions and quality to be consistent across manufactured batches.</li> <li>• Side seams must be securely glued to the top of the seam.</li> <li>• Flap crease must be pre-scored to enable the envelope flap to open flat.</li> <li>• no glue seepage must be evident on interior or exterior of envelope.</li> </ul>

cont.

# Envelope details

## Side Seam style envelope

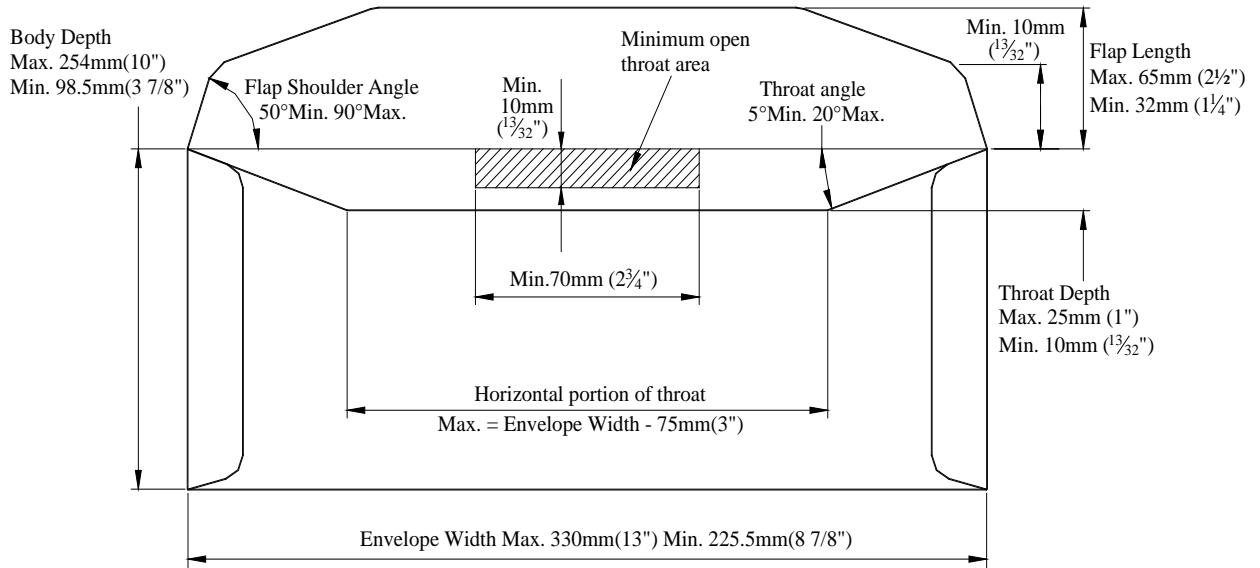

## Commercial style envelope

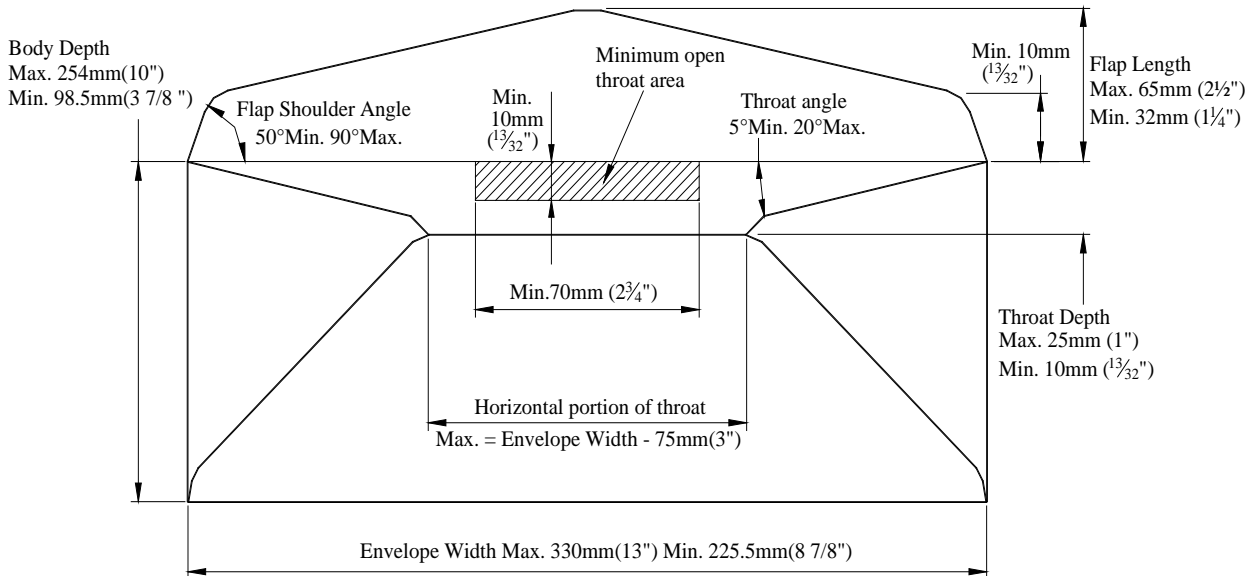



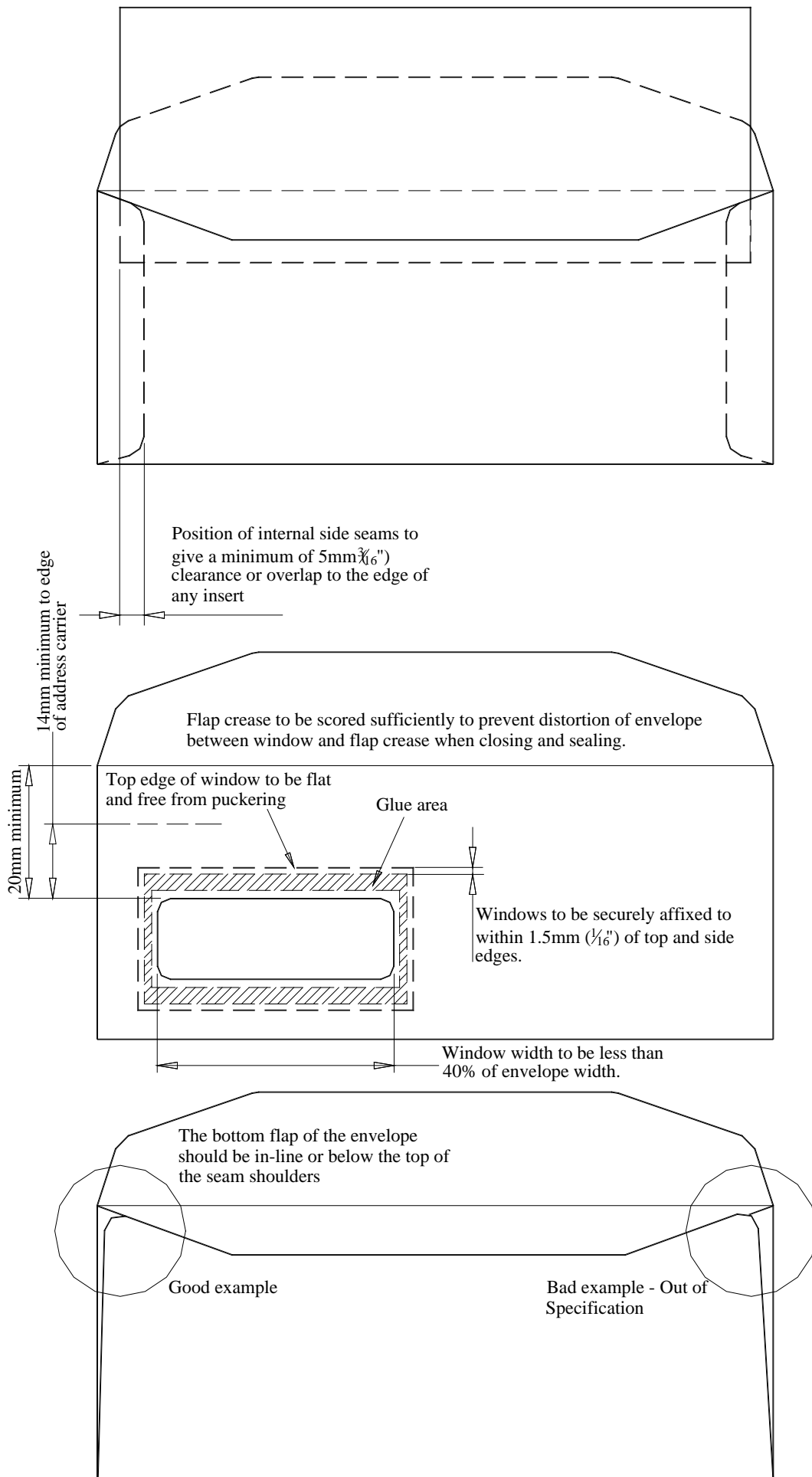

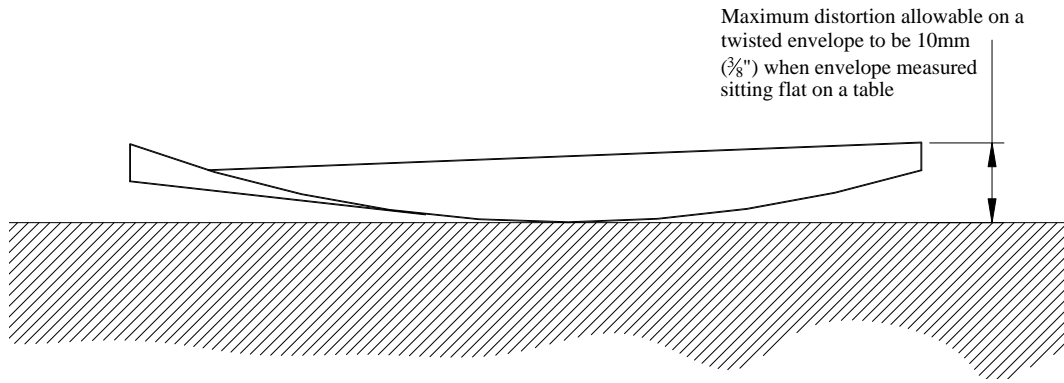

**Envelope  
sealing fluid**

Built-in wetter tank, automatically pump-fed by 10-litre wetter container located in stand. Optional low-level float switch available.

## 10.2 Flex tower

<b>Paper Size</b>	Minimum width: 148mm (5¾") Maximum width: 305mm (12") Minimum length: 93mm (3 ⅝") Maximum length: 406mm (16")
<b>Paper weight</b>	Minimum 70gsm (18lbs bond) Maximum 120gsm (32lbs bond)
<b>Folding capacity</b>	C, Z or V-fold: 8 sheets 80gsm (18lbs bond)* Double-forward fold: 4 sheets 80gsm (18lbs bond)* * Multiple folded sets dependent upon pack thickness.
<b>Hopper capacity</b>	Tower can be ordered with 1 or 2 pods, each fitted with 1 or 2 hoppers as follows:

2 x 500 sheets of 80gsm (18lbs bond)  
1 x 1000 sheets of 80gsm (18lbs bond)

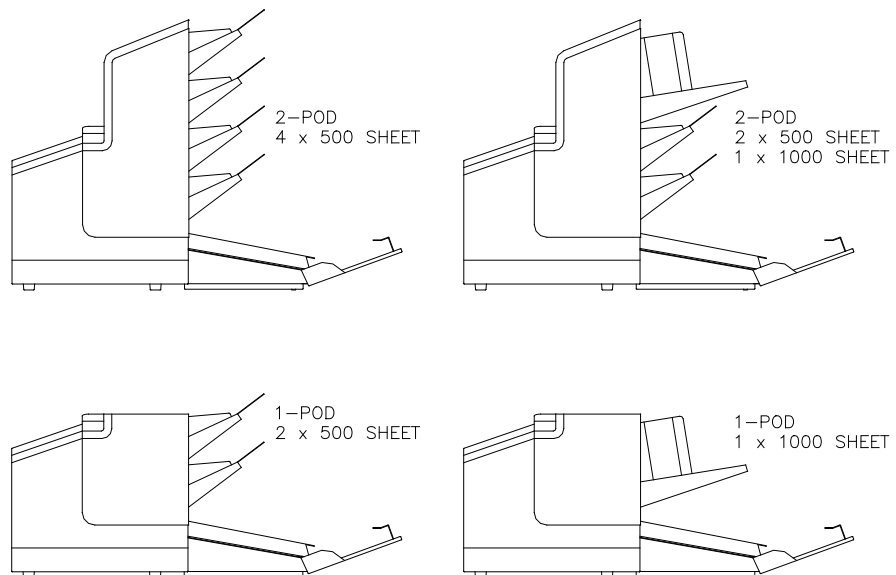

Examples shown above are for illustration only. Other configurations are available.

cont.

**Daily mail**

Up to 8 sheets of 80gsm (20lbs bond) for C, Z or V fold, up to 4 sheets of 80gsm (20lbs bond) for double forward fold, up to 25 sheets of 80gsm (20lbs bond) unfolded. May be stapled or not. Max. thickness of staple 3mm. Allowable staple positions are shown below.

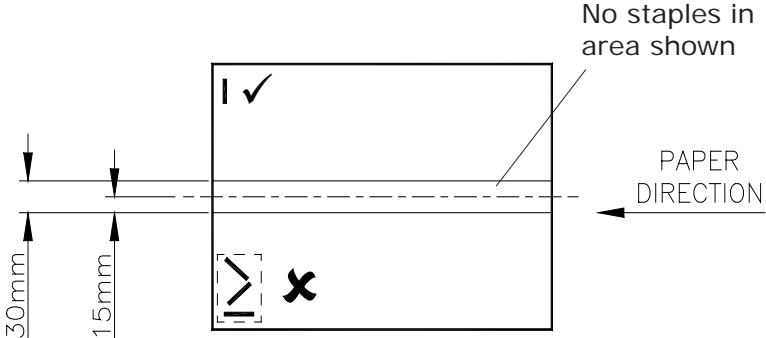

### 10.3 Versatile feeder

<b>Enclosure Size</b>	Minimum width: 148mm (5¾") Maximum width: 305mm (12") Minimum length: 93mm (3 ⅝") Maximum length: 216mm (8½")
<b>Enclosure weight</b>	Minimum 80gsm (20lbs bond) Maximum 6mm (¼") thickness
<b>Hopper capacity</b>	1000 sheets of A4 80gsm (18lbs bond) 500 sheets of A4 Z-folded 80gsm (18lbs bond) 250 x 2.4mm booklets 400 x C5 envelopes 270 x DL envelopes

Note: quantities shown above are maxima. Depending upon other conditions, actual quantities may be lower than those shown.

<b>Requirements</b>	Enclosures must be flexible enough to suit path constraints. Some enclosures may require special tyres.
---------------------	--

<b>Daily mail</b>	Up to 25 sheets of 80gsm (20lbs bond) unfolded. May be stapled or not. Max. thickness of staple 3mm. Allowable staple positions are shown below.
-------------------	--

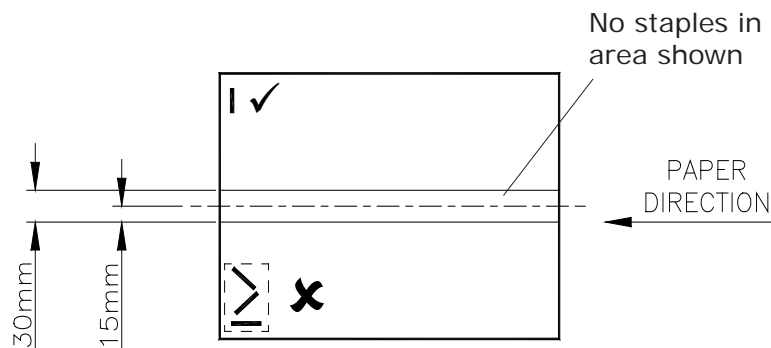

## 10.4 Mechanical & Electrical

### Noise level:

xxdba (3 x Versatile feeders, 1 x Flex tower, measured at 1.6m height, 1m from nearest cover).

### Heat Output (BTU/Hour):

Rated current x rated volts x 3.412 (eg. 2464 BTU/Hour for typical configuration of 3 x versa feeders + flex tower folder).

### Heat Output (Watts):

Rated current x rated volts (eg. 722W for typical configuration of 3 x Versatile feeders + Flex tower folder).

### Electrical:

	230VAC	115VAC
Frequency	50Hz	60Hz
Input Current	Head: 0.85A	Head: 1.6A
	Versa Feeder: 0.58A	Versa Feeder: 1A
	CIS Feeder: 0.58A	CIS Feeder: 1A
	Flex Tower: 0.55A	Flex Tower: 1.4A
Fuse Rating (Insert Head)	T6.3A	T10A

### Weights:

	Unpackaged	Packaged
Inserter Head	97Kg	122Kg
Versatile Feeder	60Kg	TBA
Flex Tower*	120Kg	TBA
Conveyor	20Kg	TBA
Stand Units	35Kg ea.	TBA

\* 2-pod version (each with 2 x 500 sheet-trays), and including accumulator with diverter tray.

### Sizes:

Inserter Head	1150L	550W	600H
Versatile Feeder	700L	550W	800H
Flex Folder*	1000L	550W	900H

\* Fitted with 4 x 500-sheet trays and accumulator

## 11 Glossary of terms

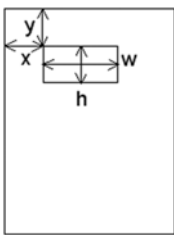
Term	Description
Address carrier	The address carrier is the document that carries the address of the person for who the mail set is meant. The address carrier can consist of one or more sheets, from which at least the first sheet must contain the address. The address must remain visible while enclosures are added and the document set is folded. The fold type and selected envelope must ensure that the address is visible behind the window in the envelope. For personalized mailings there is always an address carrier present as long as envelope printing is not supported. Normally there is one address carrier.
Address position	 <p data-bbox="635 703 1412 943">Position of the address on the address carrier, measured from the upper left corner. The address position consists of a horizontal x coordinate, a vertical y coordinate, a horizontal width w and a vertical height h.</p>
Automatic	The feature of an inserting system to automatically determine its job settings by measuring the sizes of documents and envelope. From all feeders that are loaded one sheet will be taken. Based on the maximum document length (which is also the length of the document set) and the length of the envelope the fold type is determined.
Automatic job	A job that is created with the Automatic job functionality.
Barcode Reading (BCR)	Barcode Reading is intended for reading and interpreting printed barcodes. The codes give information to the inserting system about how to build-up and handle a set.
Business Reply Envelope (BRE)	Envelope included in outgoing mail sets for addressee response purposes.
Cascading	See Feeder linking.
C-fold	See Letter fold.
Daily Post	Capability of an inserting system to manually insert mail sets one by one into the system, which are then inserted into an envelope. Optionally, depending on settings, additional enclosures can be added and the mail set can be folded. This function is intended for small amounts of mail that each can have a different build-up.
Deskew	A system of straightening a skewed document or enclosure by driving it into a set of drive rollers that have been briefly stopped. This removes the skew, and after a set period of time, the rollers restart. Deskew slows the machine down and can be disabled or adjusted for amount of deskew for forms that are not prone to skewing.
Document	A document is one of the components of a mail set. A document can consist of one or more sheets. Documents can be divided into address carriers and enclosures. For personalized mailings there is always one address carrier and an optional number of enclosures.

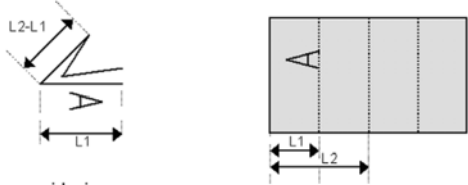
Term	Description
Document set	The document set is the physical collection of address carrier and enclosure(s) that is under production in the inserting system. The document set is completed during production and is to be inserted into the envelope. The number of enclosures can range from 0 to the limit imposed by the number of available feeders, whilst observing the overall pack thickness. Once the document set has been inserted into an envelope it is called mail set.
Double Document Detection	Double Document Detection is the sensor that measures the thickness of a sheet to check if the inserting system does not accidentally take more sheets than intended. DD sensors exist on feeders (double sheet detection). Currently DD detection on Neopost inserting systems perform relative measurements, which means that they need a cycle to 'learn' the thickness of a sheet. Also the length of the document is measured so partly overlapping sheets will be detected.
Double parallel fold	The double parallel fold is a type of fold where the document is first folded halfway and the resulting folded set is again folded halfway. This fold is illustrated in the picture below. The position of both folds is adjustable. 
Envelope	The envelope is the packaging of a mail set. Window envelopes are envelopes that have a transparent section through which the address on the address carrier can be read. Besides the normal top closing window envelopes there are also bottom closing envelopes.
Face down	Situation in which the front of a sheet is facing downwards when placed in a document feeder.
Face down leading	Situation in which the front of a sheet is facing downwards and the top of the sheet is closest to the separation unit in a document feeder, ie. the front end of the tray.
Face down trailing	Situation in which the front of a sheet is facing downwards and the bottom of the sheet is closest to the separation unit in a document feeder, ie. the front end of the tray.
Face up	Situation in which the front of a sheet is facing upwards when placed in a document feeder.
Face up leading	Situation in which the front of a sheet is facing upwards and the top of the sheet is closest to the separation unit in a document feeder, ie. the front end of the tray.
Face up trailing	Situation in which the front of a sheet is facing upwards and the bottom of the sheet is closest to the separation unit in a document feeder, ie. the front end of the tray.
Feeder	A feeder is a module for the input of documents to the inserting system. The feeder separates documents sheet by sheet from the stack of documents in the feeder tray.

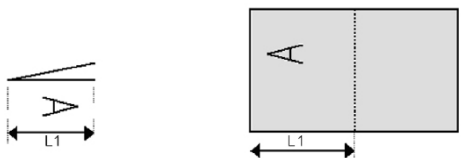

Term	Description
Feeder linking (Cascading)	The ability to load two feeders with the same document type where the inserting system automatically switches to a second feeder when the first feeder is empty and vice versa. In the meantime the first feeder can be refilled, so the inserting system can keep running without having to stop for refilling the feeders.
Feeder tray	Part of the feeder that contains the stack of documents or envelopes.
Flexcode OMR	An OMR code for which the meaning of the OMR marks can be programmed in a dedicated way for a specific customer. This is normally used to support the OMR codes from other suppliers.
FlexFeed®	The flexFeed® is the feeding part of the system.
High Capacity Feeder	Feeder that has a capacity up to 1000 sheets (on a Tower unit).
High Capacity Vertical Stacker	Optional stacker that is mounted on the exit of the system, to stack filled envelopes.
Insert	<ul style="list-style-type: none"> <li>• To insert is the action of inserting a document set into an envelope.</li> <li>• For native English speaking customers an insert is also a short document, not to be folded, usually an enclosure.</li> </ul>
Inserter	An inserter is the module where the document set is inserted into the envelope, the envelope is closed and if necessary sealed.
Inserting system	The system of all the modules that cooperate to perform the inserting function (accumulate document set, fold and insert) and have a single point of control.
Insert'n Frank™ (mailing system)	Interface for the Neopost franking system.
Job	<p>A job is an actually produced collection of mail sets based on a certain job definition at a certain point in time for a specific purpose. It consists of:</p> <ul style="list-style-type: none"> <li>• The job definition used for the production</li> <li>• Information about the batch size</li> </ul>
Job counter	The counter that registers the number of mail sets that is produced as part of a specific job.
Letter fold (also known as C-fold)	Fold type in which a document set is folded twice in which the folded flaps are on top of each other. This fold is illustrated below. The position of both folds is adjustable.
Linking	See Cascade.
< ! W d Z Y X Y f	Feeder with high capacity feeder tray.
Multiples	The feature of an inserting system in which more than one sheet is taken from a feeder.
OMR	Optical Mark Recognition (see further table entry).
OMR code definition	Standard 1-track OMR code definition. Specifies the amount of reading marks used and the functionality linked to each of them (how each should be interpreted). A definition is a licenced option.
Operator	The person operating an inserting system.

Term	Description
Optical Mark Recognition (OMR)	Optical Mark Recognition is intended for reading and interpreting printed codes. These codes are one or more black marks which are read from a document. These marks give information to the inserting system about how to build-up and handle a set.
Output Conveyor	Fitted at the output for filled envelopes to be ejected onto. Higher capacity alternative to a receiving tray. 2 lengths are available.
Pod	The feed hopper unit fitted to a Tower. A Tower is available with either 1 or 2 pods, each one consisting of either 2 x 500-sheet trays or 1 x 1000-sheet tray.
Reading error	Condition in which the system could not reliably read or interpret the OMR reading marks or barcode from a sheet.
Reading marks	Marks added to documents containing finishing instructions that can be identified by a reading head and interpreted according to the used OMR code definition.
Receiving tray	Fitted at the output for filled envelopes to be ejected into. Basic alternative to an Output Conveyor.
Remote diagnostics	The feature that makes it is possible to analyze a problem on an inserting system from a remote location.
Service engineer	Technical engineer whose task it is to resolve problems with systems in the field. Besides dealing with problems, service engineers are also responsible for preventive maintenance.
Single fold	<p>A single fold implies the document set is folded once. The fold position is adjustable. This fold is illustrated below:</p> <div style="text-align: center;">  </div>
Stop counter	Counter which sets the amount of envelopes to be filled. After filling this amount of envelopes the system will stop.
Supervisor	Person who is responsible for the technical state of the system. Normally a supervisor has access to programming functions, which are restricted for standard users.
Test run	<p>A test run is intended to validate the settings of the inserting system:</p> <ul style="list-style-type: none"> <li>• Inspect and adjust the stop position of the envelope.</li> <li>• Check the fold settings for one set.</li> <li>• Check whether the address is correctly positioned behind the envelope window.</li> </ul>
Tray (or hopper)	Contains a stack of paper for a printer or inserter. This paper is supplied to the system for further processing.
Vertical transport	The vertical transport section between hoppers and folder/ collator below .

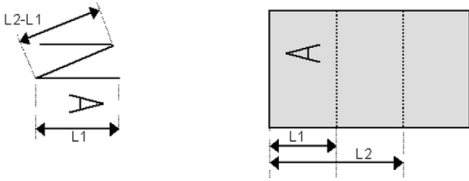
Term	Description
<p>Z-fold (also known as zigzag fold)</p>	<p>A Z-fold means that a document is folded twice in such a way that each folded flap is on a different size of the folded document, resulting in a Z-shape. This fold is illustrated below. The position of both folds is adjustable.</p> <div style="text-align: center;">  </div>

**Page intentionally  
left blank**