

# FORMAX<sup>®</sup>

---

6206 Series  
Low-Volume Desktop Inserters

# Table of Contents

<b>1</b>	<b>Read this First .....</b>	<b>1</b>
	Warning.....	1
	About this manual.....	1
	Safety.....	2
<b>2</b>	<b>Meet your Document System .....</b>	<b>5</b>
	Power Up.....	5
	Overview.....	5
	Control Panel and Home Menu.....	9
	Job Menu.....	10
	Loading Documents.....	12
	Loading BREs (option).....	14
	Loading Envelopes.....	16
	Filling the Sealing Liquid Bottle.....	18
	Shut Down the System.....	20
<b>3</b>	<b>Processing Mail Sets .....</b>	<b>21</b>
	New Mail Sets.....	21
	Basic Mail Sets .....	22
	Mail sets with BRE or inserts.....	22
	Daily Mail.....	23
	Fold Only.....	24
	Multi Feed.....	25
	Change Fold Type.....	26
	Address Position.....	27
	Run a Batch.....	27
	Linking Feeders.....	28

<b>4</b>	<b>Working with Jobs</b>	<b>29</b>
	What Is A Job	29
	Save Settings to a Job	30
	Selecting a Job	31
	Edit a Job	32
	Delete a Job	33
<b>5</b>	<b>Advanced Settings</b>	<b>34</b>
	Introduction	34
	Setting the Language, Date and Time	34
	Licensed Options	35
	Add an Option	36
<b>6</b>	<b>Reading</b>	<b>37</b>
	Introduction Reading	37
	BCR Code	39
	Adjusting Reading Settings	46
	Test Reading with BCR	41
	Process Mail Sets with BCR	42
	OMR Code	43
	Adjusting Reading Settings	46
	Test Reading with OMR	47
	Process Mail Sets with OMR	47
<b>7</b>	<b>Online Services</b>	<b>48</b>
	Online Services Introduction (OLS)	48
	Connection Settings	48
	LAN Configuration for OLS	49
	Analogue Modem Configuration for OLS	50
	Connecting To The Online Server	51
	Viewing Connection History	52
	Viewing Messages	53
	Downloading and installing jobs and software with OLS	54

<b>8</b>	<b>Operator Maintenance</b>	<b>55</b>
	Maintenance Schedule	55
	Clean or Replace the Brush	56
	Replace separation rollers of the document feeder	59
<b>9</b>	<b>Fault Finding</b>	<b>62</b>
	Error Messages	62
	Clearing Stoppages	63
	Calibrate Sensors	68
	Troubleshooting	69
	Troubleshooting Tables	69
<b>10</b>	<b>Specifications</b>	<b>75</b>
	Technical Specifications	75
	Feeder and Stacker Capacities	76
	Dimensions	76
	Document and Insert Specifications	77
	Envelope Specifications	78



# 1 Read this First

## Warning

---



Ensure you have read and fully understood the safety requirements in this section.

## About this manual

---

### Software

The software used for the reading option is based in part on the work of the Independent JPEG Group.

### Audience

This manual is meant for operators of the document system.

## Symbols

This manual uses the symbols listed below.



**WARNING** : Indicates a human safety hazard.



**ATTENTION** : A risk to the equipment or mail could result from an action you may perform.



**NOTE** : A remark that explains different cases or specificities.



**TIP** : Advice to help save you time when processing your mail.



**SUPERVISOR** : Indicates that you have to use the supervisor menu to perform the procedure.

---

## Safety

---

### Warnings

- Disconnect the power supply before performing any maintenance.
- Before connecting the system to the electrical supply, ensure that the system is suitable for the local mains voltage. Refer to the serial plate on your system for voltage requirements.

### Precaution

The general process of automated document handling can sometimes create a build up of static electricity. Therefore we recommend that the following measures are taken to reduce the side effects of any electrostatic charge.

- Make sure that you operate the system within the recommended temperature and humidity conditions.
- Make use of antistatic mats where appropriate.
- If necessary, make use of an ionizer to reduce static charge build up in the room where the system is located.

Please contact your supplier for further information.

## Safety Precautions

- Only competent, trained personnel should operate this system. If non-trained personnel do operate this system, the manufacturer will not accept responsibility for any resulting accidents or injuries.
- Only skilled persons, who are aware of the risks involved, may open the protective covers.  
For safety reasons, the system will not function when the covers are open.
- Keep long hair, fingers, jewelry, etc. away from rotating and moving parts.
- The power connection must be easily accessible, preferably close to the system.  
For safety reasons, it is essential that the system is connected to a socket outlet that has a protective earth (ground) connection.
- Overcurrent protection in the equipment also relies on the branch circuit protection (max. 20 A).
- The following part(s) is (are) considered the equipment disconnect device(s):
  - Power supply cord plug or appliance coupler.



### CAUTION: DOUBLE POLE / NEUTRAL FUSING

(this means that after operating of the fuse, parts of the equipment that remain energized, might represent a hazard during servicing.)





# 2 Meet your Document System

## Power Up

---

Make sure the system is connected to the power supply.

1. Press the **On/Off** button  next to the display.

The touch screen shows the Home Menu.

---

## Overview

---

### Introduction

The 6206 Series is a folding and inserting system for processing mail easily. The system:

- Feeds documents
- Folds the documents
- Inserts the documents into envelopes
- Seals the envelopes
- Stacks the envelopes

Automatic monitoring ensures the correct number of documents per envelope. The system is equipped with a variety of special features: double feed control, feeder linking, multi feed, daily mail, reading (option) and a vertical stacker.

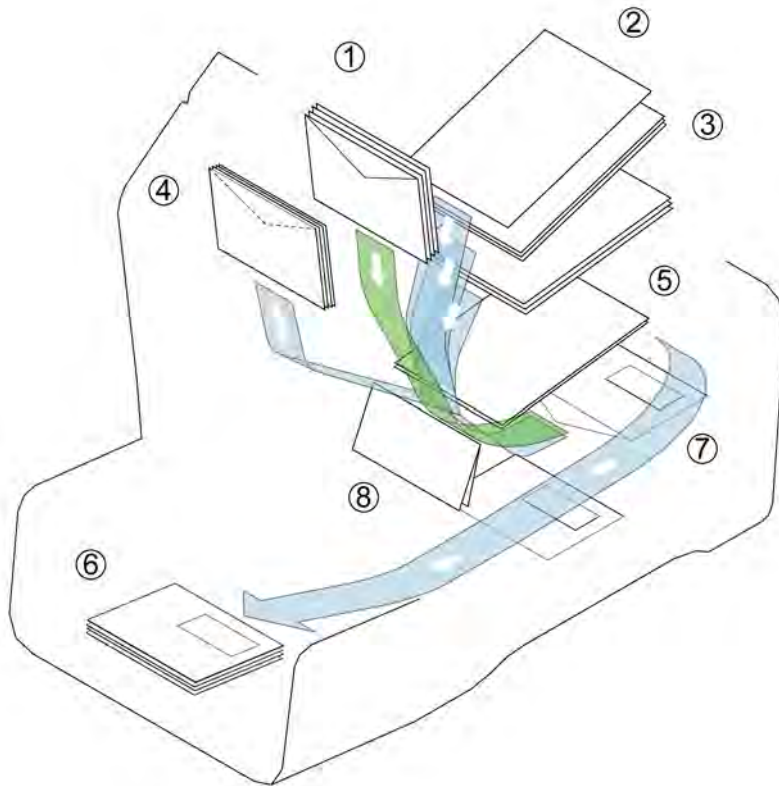

The figure shows an overview of the 6206 Series.

### **Envelope Hopper (1)**

The envelopes are picked up and transported to the insert position (7) inside the system.

### **Document Feeders (3)**

Depending on the configuration, one or two document feeders are available. The upper feeder is the main document feeder, the lower feeder is the enclosure feeder. The system can feed one or more documents (multi feed) from one feeder. The feeders have a double feed control (DFC). DFC detects if one or more documents are fed at the same time.

If two document feeders are available, you can use Feeder Linking. This means that two feeders can be linked as pairs. When the first feeder is empty, the system switches to the other feeder, and vice versa. Meanwhile the empty feeder can be refilled without stopping the system.

### **Daily Mail (2)**

At the envelope hopper an extra document feeder is available for 'daily mail' (2). You can use this feeder to process sets of documents that you cannot process automatically (for example: stapled documents and sets with varying thickness).

## **BRE or Insert Feeder (4) (Optional)**

The system is (optionally) equipped with a special feeder for Business Reply Envelopes (BRE) and other small inserts.

## **Collating Area (5)**

All documents of a document set are assembled in the collating area.

## **Fold (8)**

The fold unit folds the documents. The following fold types are possible (see Terminology):

- No fold
- V-fold
- C-fold
- Z-fold
- Double V-fold

## **Inserter (7)**

After the documents are folded, the documents are transported to the inserter. The inserter inserts the documents into a waiting envelope. The inserter seals the envelope or not, depending on the settings.

## **Stacker (6)**

When the envelope leaves the system it is stacked in the stacker.

## Connections

The document system has the following connections:

A: Power connection

B: LAN: for the Online Services connection

C: Mini USB port (device): for a connection to a PC, for service purposes only

D: USB port (host): for an analogue modem or connection to an USB flash drive

E: RS232 port: for the connection with a franking/mailing machine

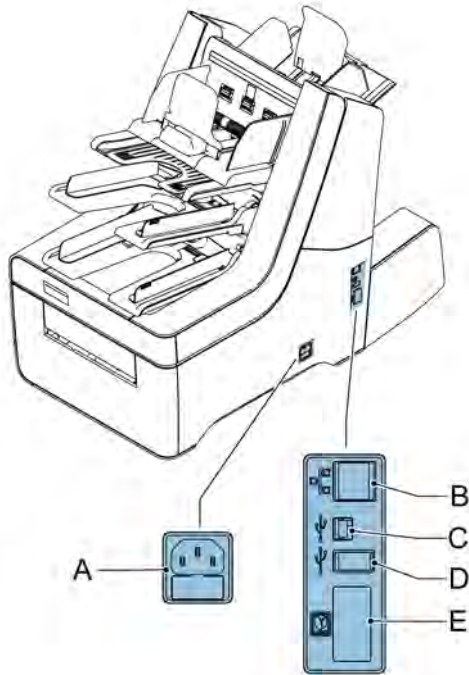

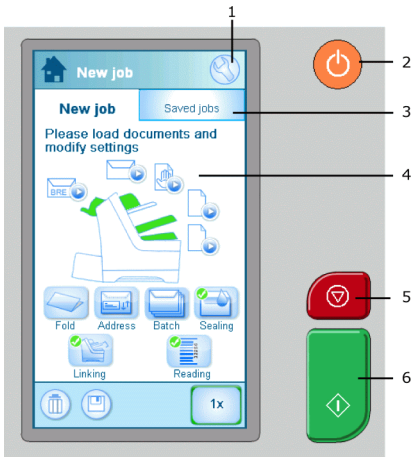

# Control Panel and Home Menu

When you start the system the Home menu appears.



1. Depending on which screen is open, one of these two menu icons will be displayed:

-  - The Settings icon opens the Settings Menu.
-  - The Home icon opens the Home Menu.

2. ON/OFF Button: Turns the system ON or OFF. If the system is not used for one hour, the system switches to power save mode. Press the ON/OFF button to switch back to user mode.

3. Saved Jobs Screen: Displays a list of available settings (jobs).

4. Home Screen: Shows your document system with available feeders and settings.

5. STOP Button: Press the STOP button to complete the current mail set.

6. START Button: When you press the START button, the system starts to feed documents and envelopes from feeders where material is detected. In other menus, the START button will start to process mail sets.

# Job Menu





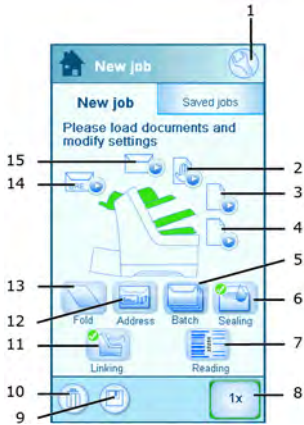











The New Job Menu is displayed when:

- The system is started.
- The Home  icon is pressed.



A green feeder indicates that the system detected documents or envelopes in the indicated feeder.















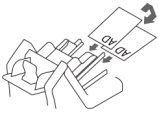

The following is a list of icons and their descriptions.

	<p><b>1. Home / Settings menu</b></p>		<p><b>9. Save</b> Saves the current job. You can save a job after one set is created.</p>
	<p><b>2. Daily mail</b> Turns daily mail on/off.</p>		<p><b>10. Recycle bin</b> Deletes the current job.</p>
	<p><b>3. Main Document feeder</b> Sets the number of documents to be fed from the main document feeder.</p>		<p><b>11. Feeder Linking</b> Turns linking on/off. Linking means that when one feeder is empty, the system automatically starts feeding documents from the other feeder. A symbol at the feeders shows if the feeders are linked or not.</p>
	<p><b>4. Enclosure document feeder</b> Sets the number of documents to be fed from the enclosure feeder.</p>		<p><b>12. Address Position</b> Sets the address position. If the address is not fully visible through the envelope window, use this button to adjust the position.</p>
	<p><b>5. Batch counter</b> Sets the number of sets that must be processed for each batch.</p>		<p><b>13. Fold type</b> Sets the fold type. Which fold types are available depends on the documents and envelopes in the system.</p>
	<p><b>6. Sealing</b> Turns sealing on/off. When sealing is off, the flap of the envelope is closed but not moistened.</p>		<p><b>14. BRE</b> Turns BRE feeder on/off.</p>
	<p><b>7. Reading</b> Turns reading on/off (BCR or OMR).</p>		<p><b>15. Envelope hopper</b> Turns envelopes on/off. For fold only mode, set the envelopes to <b>No</b>.</p>
	<p><b>8. 1x</b> Starts a test run.</p>		<p><b>Information</b></p>



## Loading Documents

The table below shows how to load documents depending on the fold type, and the optional Enclosure and BRE feeders. See the job information on the touch screen.

	 one document	 feeder linking	 document + enclosure	 document + BRE/insert
no fold 	 Address carrier in upper feeder. Face up and leading.	 Address carrier. Face up and leading	 Address carrier in upper feeder. Face up and leading.	 Address carrier in upper feeder. Face up and leading.
V-fold 				
C-fold 				
double V-fold 				
Z-fold 	 Address carrier. Face down and trailing.	 Address carrier. Face down and trailing.	 Address carrier in lower feeder. Face down and trailing.	 Address carrier in upper feeder. Face down and trailing.

### To load documents:

1. Rotate thumb wheel A to move the side guides apart on the feeder.

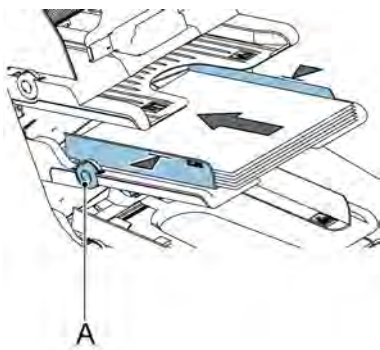

- Put a small stack of documents between the side guides.
- Move the side guides toward the documents. The play between the side guides and the documents should be about 0.5 mm (0.02").



Use an envelope to measure the play. If an envelope fits between the documents and the side guides over the whole length of the feeder, the play is correct.

- Place a stack of documents in the feeder, do not place more documents than indicated by the "max" symbol on the feeder. See the previous figure for the correct orientation.

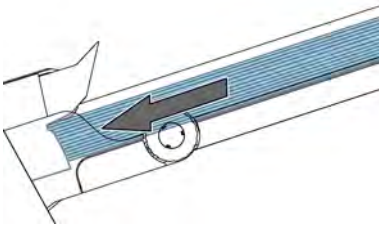

Make sure the paper touches the stop.



Refer to the specifications for the maximum amount of documents you can load into the feeder.

## Loading BREs (option)

---

You can use the optional BRE feeder for small insert cards or BREs.

### To load BREs:

1. Rotate thumb wheel A to move the side guides apart.
2. Pull back support B.
3. Put a small stack of documents or BREs between the side guides.
4. Release back support B.
5. Move the side guides toward the documents or BREs. The play between the side guides and the documents should be about 0.5 mm (0.02").



Use an envelope to measure the play. If an envelope fits between the documents and the side guides, the play is correct.

6. Place a stack of documents or BREs in the feeder. See the figure for the correct orientation. In case you use BRE's, ensure that the envelope flap is facing you and in downward position, see picture.

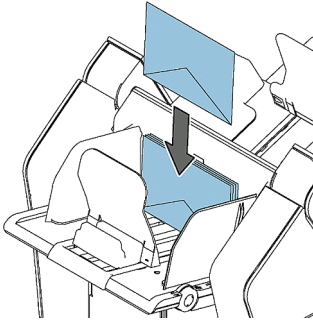

Refer to the specifications for the maximum amount of documents or BREs you can load into the feeder.



You can also use C5 BREs. These will be folded and inserted. If you want to use C5 BREs, position them in the feeder as shown in the figure.

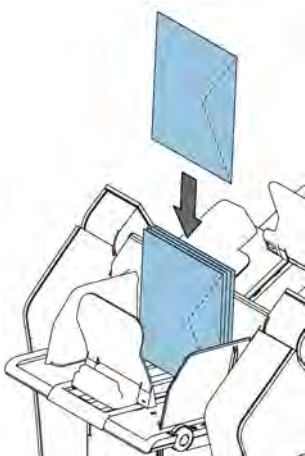

## Loading Envelopes

---

Loading envelopes correctly will help prevent jams and mis-feeds.

**To load envelopes:**

1. Rotate thumb wheel A to move the side guides apart.

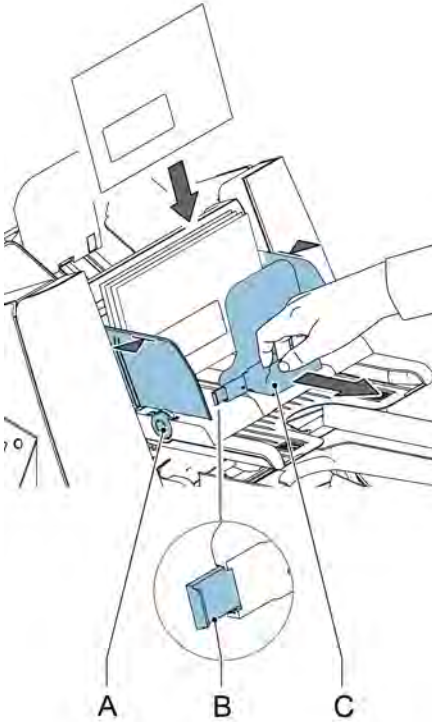

2. Pull back support C.
3. Put a small stack of envelopes between the side guides.

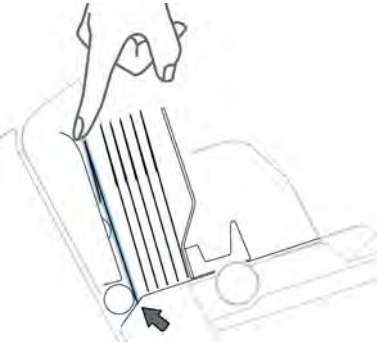

4. Release back support C.
5. Move the side guides towards the envelopes. The play between the side guides and the envelopes should be about 0.5 mm (0.02").



Use an envelope to measure the play. If an envelope fits between the envelopes and the side guides, the play is correct.

6. Extend supports B when you work with wide envelopes.
7. Place a stack of envelopes in the hopper (see figure).



Refer to the specifications for the maximum amount of envelopes you can load into the feeder.

8. Set the side guides of the stacker according to the envelope width. Rotate B to move the side guides. Use the indicators C on the fingers to determine the side guide position. If necessary, remove extensions D.

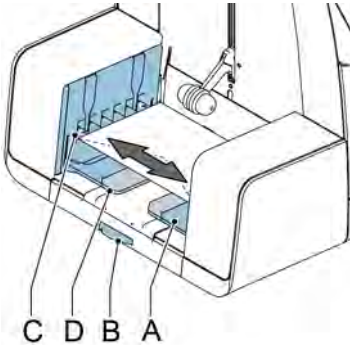

## Filling the Sealing Liquid Bottle

---

The system uses sealing liquid for sealing envelopes. If the system is out of sealing liquid, the mailing process continues but the envelopes will not be sealed properly. The sealing liquid level detection system will warn you when your sealing liquid bottle is almost empty.

**Fill the sealing liquid bottle as follows:**

1. Push A to open the system.

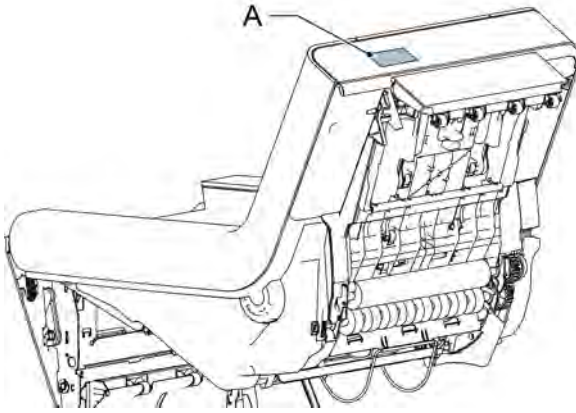

2. Remove the sealing liquid bottle.

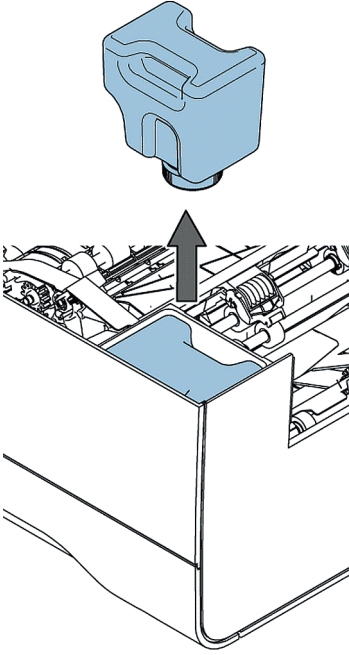

3. Place the bottle on its bottom and turn the cap (bayonet thread) to open.

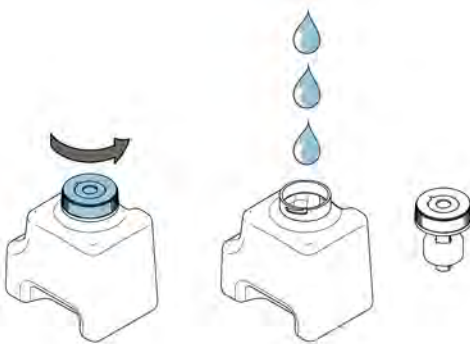

4. Fill the bottle with sealing liquid up to the filling level indicator and close it.



Fill the sealing liquid bottle with the sealing product that is recommended by your dealer. Any other product or water can cause problems with the functioning of your system.



5. Place the bottle in the system. Ensure that bottle is placed correctly.

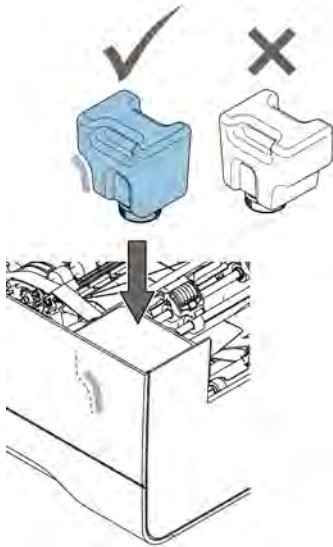

6. Close the system.

---

## Shut Down the System

---

1. Press the **[On/Off]** button  to shut down the system.

When the system is busy, it completes and inserts the current set, stops and will be shut down.

---

# 3 Processing Mail Sets

## New Mail Sets

From the Home menu you can process new mail sets like:

- Basic mail sets
- Mail sets with inserts/BRE
- Daily mail
- Fold only

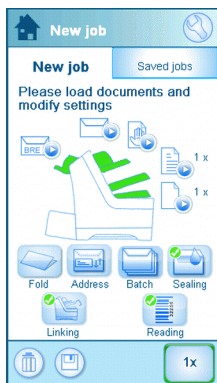

The system automatically detects documents, envelopes and BREs in the feeders. The picture of the appropriate feeder changes color to indicate that documents are present. Only the feeders where documents are present are used to process mail sets.



Make sure that the liquid reservoir is filled to enable sealing envelopes.

## Mail set options

In the Home menu you can set the following options for processing mail sets:

- Address position
- Batch processing
- Feeder linking
- Multi feed
- Other fold type
- Reading (option)
- Sealing on or off

## Basic Mail Sets

---

A basic mail set consists of documents from one or more document feeders. This set is inserted into an envelope.

Before you start, make sure you have read the introduction on [processing mail sets](#) on page 21.



In a test run, the envelope is not sealed.

1. Load the documents and envelopes into the feeders.
2. If necessary, change the fold type.
3. Press the Test Run **[1x]** icon to create one mail set and follow the instructions on screen.
4. Press the green **[Start]** button to start the mail set production.

The system stops producing mail sets when one of the feeders is empty or the red **[Stop]** button is pressed.

---

## Mail sets with BRE or inserts

---

A mail set with BRE consists of documents from one or more document feeders and an insert/BRE from the BRE feeder. This set is inserted into an envelope.

Before you start, make sure you have read the introduction on [processing mail sets](#) on page 21.



In a test run, the envelope is not sealed.

1. Load the documents, BREs or inserts, and envelopes into the feeders.
2. Press the Test Run **[1x]** icon to create one mail set and follow the instructions on screen.
3. Press the green **[Start]** button to start the mail set production.

The system stops producing mail sets when one of the feeders is empty or the red **[Stop]** button is pressed.

---

## Daily Mail

---

Daily mail relates to small amounts of mail that each can have a different configuration. You can insert the mail sets manually one by one into the system and add any BREs and enclosures. The set is folded and inserted into an envelope. Fold only is also possible with daily mail, see [fold only](#) on page 24.

Before you start, ensure you have read the introduction on [processing mail sets](#) on page 21.



The daily mail feeder has a fixed width (letter). We recommend you to use only documents of this size.

1. Feed a daily mail set as indicated in the figure.

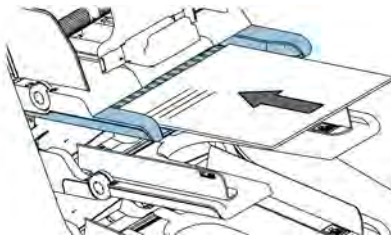

2. Press the Test Run **[1x]** icon to create one mail set and follow the instructions on the screen.
3. Insert the next set into the daily mail feeder.

As soon as the system detects the daily mail set, the system folds and inserts it into an envelope.

---

## Fold Only

---

If you only want to fold documents and do not want to insert a set into an envelope (fold only).

3

English

1. Remove the envelopes from the envelope hopper or set  the envelope setting in the Home menu to **No**. The display shows a warning that you have to select a fold type.



2. By default the V-fold is selected, to change the fold type follow the instructions on the screen.
3. Load documents in the document feeders, BRE feeder or daily mail feeder.
4. Press the Test Run **[1x]** icon to create one folded document set.
5. Press the green **[Start]** button to start the folding or in case of daily mail, feed the daily mail set.

The document sets are folded and stacked in the stacker.

---

## Multi Feed

---

From a feeder, you can feed more than one document for your document set. This is called Multi Feed.



Multi feed is not available on the BRE feeder.

1. Press the Document Feeder  icon next to one of the feeders.
2. Press the + or - button to set the number of sheets.

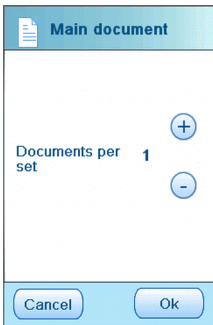

3. Press the **[OK]** button to confirm.
-

## Change Fold Type

---

In most cases, the system chooses the fold type automatically. If you want to use a different fold type or change the location of the fold position, proceed as follows:

1. Press the Fold Type  icon to select a fold type.

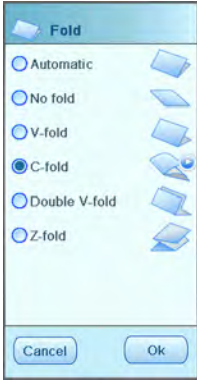

After a test run, at the fold type icon an  (arrow) is visible.

2. When you press the , the Fold Length screen is displayed. The fold length screen allows you to define specific fold length settings. Or select **Automatic** to let the system determine the fold length.

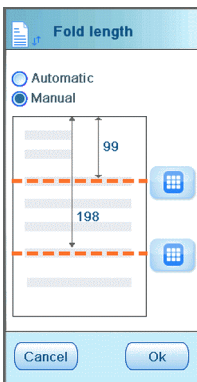

3. Press the **[OK]** button to confirm.
-

## Address Position

---

If the address on your mail is not correctly positioned behind the envelope window, change the address position as follows:

1. Press the Address Position  icon. The address position screen appears.
2. Press the + or - button to adjust the address position in the envelope.

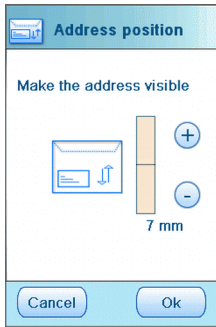

3. Press the **[OK]** button to confirm.
4. Press the Test Run **[1x]** icon to test the new address position.

---

## Run a Batch

---

If you have to run a fixed number of mail sets, you use batch.

1. Load the documents, BREs or inserts, and envelopes into the feeders.
2. Set any options like feeder linking and multi feed.
3. Press the Batch Counter  icon to set the number of mail sets the system should create.
4. Press the Test Run **[1x]** icon to create one mail set and follow the instructions on the screen.
5. Press the green **[Start]** button to start the batch.

The system stops producing mail sets when the batch is finished, one of the feeders is empty, or the red **[Stop]** button is pressed.

---



## Linking Feeders

---

If two document feeders are available, you can use feeder linking. This means that two feeders can be linked as pairs. When the first feeder is empty, the system switches to the other feeder, and vice versa. Meanwhile, the empty feeder can be refilled without stopping the system. To link two feeders:

3

English

1. Press the Feeder Linking  icon. The Feeder Linking screen is displayed.



2. Select **Yes** and press the **[OK]** button to confirm.

Now both feeders are linked. In the home menu the link symbol appears.

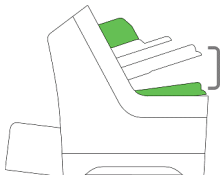

If both feeders contain documents, the system starts feeding from the Main Document Feeder.

---

## 4 Working with Jobs

### What Is A Job

---

If you have to process a lot of mail sets of the same type (for example bills), you can save the settings to a 'job'. The next time you just select the job and immediately start without defining any settings.

The following settings are saved in a job:

- Address position
- Batch counter
- Envelope type
- Feeder linking on/off
- Fold type and fold lengths
- If BREs or insert cards should be included
- Reading settings
- Sealing on/off
- Which document feeders should be used and how many documents should be fed from one feeder

## Save Settings to a Job

---

You can only save settings to a job, after a successful test run or batch.

To save your settings to a job:

1. Press the  icon in the job settings menu.

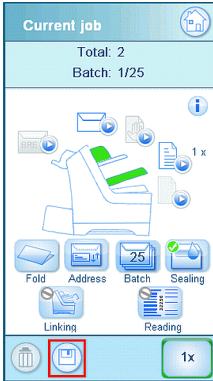

2. Follow the instructions on screen, enter a job name and press the **[OK]** button.



You can only save a job if you do at least one test run.

The job is saved, you can save up to 20 jobs.

---

## Selecting a Job

---

If you want to select an existing job:

1. From the Home menu select the **Saved jobs** tab.

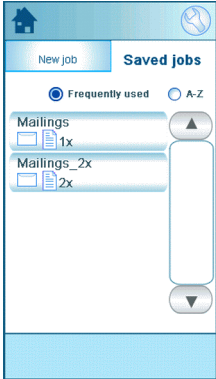

The system displays the job settings of this job. You can sort the job list, select A-Z to sort jobs alphabetically or select and sort on frequency.



If one of the feeders shows a warning symbol , it means the selected job wants to use this feeder, but the system does not find any documents or envelopes in this feeder.

2. Select a job from the job list.
3. Press the green **[Start]** button to start the job.

The system stops producing mail sets when a batch is finished, one of the feeders is empty, or the red **[Stop]** button is pressed.

---

## Edit a Job

---

If you want to edit a job:

1. Select a job from the job list.

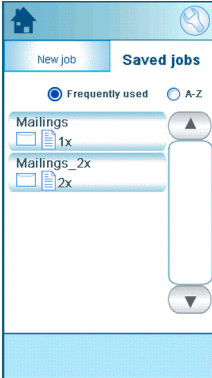

2. Edit the job settings. See [Job Menu](#) on page 10.
3. Press the save button .



4. Choose [**Overwrite**] to save the changes to the job.

The modified job is saved.

---

## Delete a Job

---

If you want to delete a job:

1. Select a job from the job list.

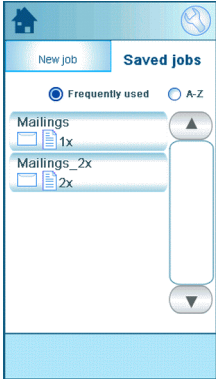

2. Press the  icon and press **[OK]** confirm.

The job is deleted.

---

# 5 Advanced Settings

## Introduction

This section explains some advanced settings. The following is explained:

- How to set the language
- How to set the date and time
- How to add an option

## Setting the Language, Date and Time

To set the language, date and time:

1. Press the  icon in the home menu to open the Settings Menu.
2. Press **[Localisation]** to change language settings.



3. Press **[Supervisor]**, **[Date and Time Settings]**, to change time settings.

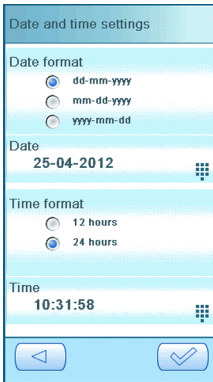

---

## Licensed Options

---

You can add the following options with a license key (special code):

- Reading (barcode and OMR)
- Online Services

For information about options that are available to your system, please contact your service organization.



## Add an Option

---

To add an option:

1. Press the  icon in the home menu to open the Settings Menu.

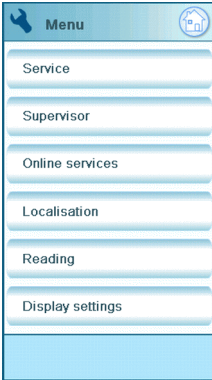

2. Press **[Supervisor]**, **[Licensed options]**. The Licensed options menu appears. The menu shows the options that are already available.

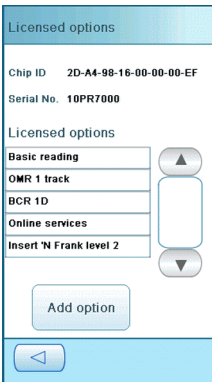

3. Press the **[Add option]** button.
  4. Enter the license key of the option you want to add and press the **[OK]** button. The option is added to the list.
-

# 6 Reading

## Introduction Reading

---

The reading option allows the system to read special codes that are printed on the documents. The code contains information about the processing of the documents. The system can read two code types:

- BCR: BarCode Recognition

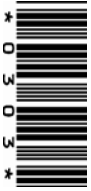

- OMR: Optical Mark Recognition

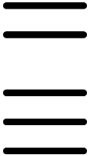

Depending on the settings, the code tells the system if:

- The document set is complete
- Enclosures must be added to the set
- The system must stop
- The set is complete (no pages are missing)



Service Technicians can set your reading function. Contact your service provider for more information.

## General Requirements for Printing Codes

If you print documents for reading:

- Make sure the ribbon or toner quality is sufficient.
- Print the code in black.
- Codes on the same sheet must have equal intensity.
- Print the code at the same position on every sheet.
- Be aware of "background noise". The reading function can be disturbed by color changes on the form; background design; or a logo or copy on the opposite side of the sheet that will bleed through.



For more information on how to print a reading code on your documents, contact your service organization.

# BCR Code

The following is the correct position of the BCR code on a document. The system can read 1D vertical and horizontal barcodes.

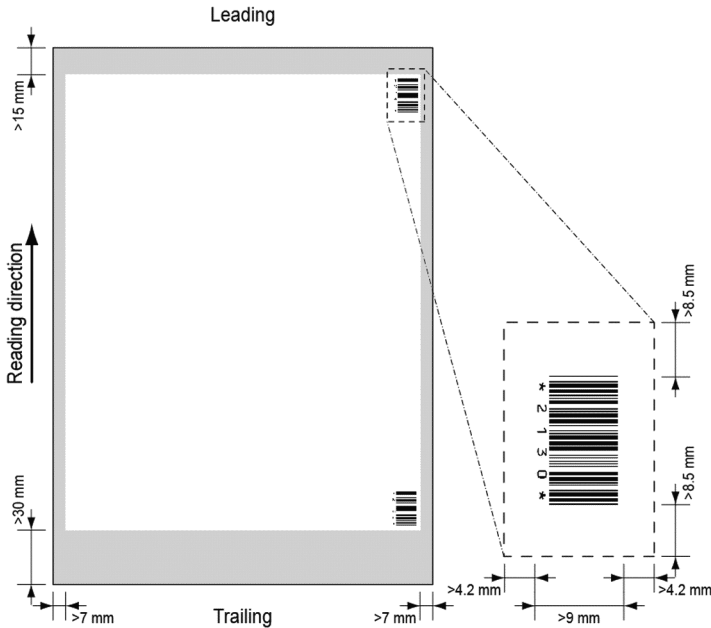

Minimum line thickness of a bar: 0.25 mm (0.01").

The thickness ratio of thick bars versus thin bars: 2.2.



The white area in the picture shows the limits where the code can be printed.

## BCR License Types

There are two BCR license types:

- Basic
- Advanced

## BCR Basic License

For the BCR basic license the following functions are available:

- Page N of M: As long as N is below M, the document set is not complete. As soon as N=M, the set is complete and will be inserted into an envelope.
- Insert/Accumulate: Defines when a document set is complete and must be inserted into an envelope.

For BCR at least one of the two basic functions (page N of M or insert/accumulate) is required.

## BCR Advanced License

For the BCR advanced license the following functions are available:

- The basic functions (page N of M and insert/accumulate).
- Sheet sequence: every sheet has a number, regardless of the document set it is part of. If a sheet is missing, an error is generated.
- Group sequence: every document in a set has the same group number. If one document set is missing, an error is generated.
- Divert: the system stops. Remove the set from the collator.
- Stop: the system stops. Remove the set from the collator.
- Selective feed: if the system reads the function, an enclosure from the enclosure feeder is added to the set. This function is printed on the last sheet of a set.

For BCR at least one of the two basic functions (page N of M or insert/accumulate) is required.

## Adjusting Reading Settings

---

To define the reading settings:

1. From the Settings Menu press **[Reading]**, the reading menu appears.

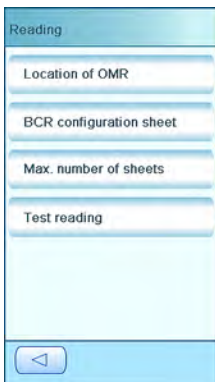

The following functions are available:

- Location of OMR, set the position of the OMR code on a document: not relevant to BCR.
  - BCR configuration sheet: Set BCR configuration code by reading a sheet with a configuration code: not relevant for OMR.
  - Max. Number of Sheets: Define the maximum number of sheets in a document set. Ensure that the number of sheets does not exceed the maximum folding capacity.
  - Test Reading: Test if the reading settings are satisfactory.
- 

## Test Reading with BCR

---

Before you start a job with reading, execute a test to ensure that:

- The system finds the reading code on the document.
- The reading code is of sufficient quality.

To test reading:

1. From the Settings Menu, press **[Reading]**.
2. Press the **[Test reading]** button.
3. Select a BCR job. Use your own reading job or use the default test BCR job.
4. Press the **[Test]** button and follow the instructions on screen.

The system tries to locate the barcode on the sheet.

If the system indicates 'No BCR read', check the following:

- The system could not find a code on the sheet, because of **bad printing quality** on page 37.
  - The system read a code, but it did not match the code type as defined in the system. Contact the service organization for more information on the code definition.
-

## Process Mail Sets with BCR

---

To process mail sets with BCR, select a BCR job or proceed as follows:



The reading settings for OMR / BCR are set in the reading menu. See [Adjusting Reading Settings](#) on page 46.

1. Load the documents and envelopes into the feeders. Place the documents with the barcodes in the main document feeder, see for more information about the orientation: [BCR code](#) on page 39.



The first sheet of a set always contains the address. The code must appear in the same location on every page.

2. If necessary, change the fold type. A Z-fold is not possible.



3. Press reading  icon and choose Barcode.
4. Press the Test Run [1x] icon to create one mail set and follow the instructions on screen.
5. Press the green **[Start]** button to start the mail set production.

# OMR Code

The following is the correct position of the OMR code on a document.

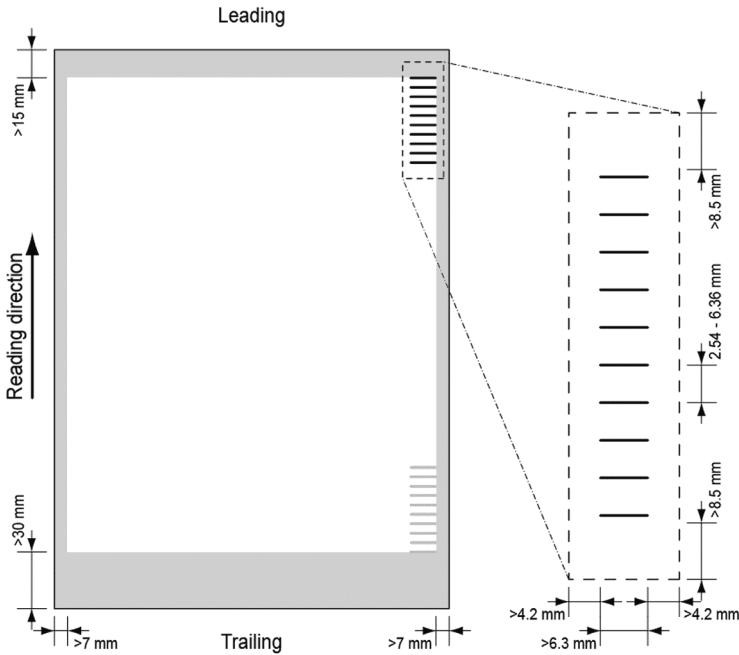

Minimum line thickness of a mark: 0.2 mm (0.008")

Default the first mark from the top is set to: 100 mm (3.9").

This parameter is set in the **[Service Settings menu]**, **[Reading]**, **[Optical Mark Reading]**. The code must have a consistent number of marks on every page.



The white area in the picture shows the limits where the code can be printed.

## OMR License Types

There are two OMR license types:

- Basic
- Advanced



# OMR Basic License

For the OMR basic license, the following functions are available:

- Start Mark: Indicates the start of the code.
- Insert/Accumulate: Defines when a document set is complete and must be inserted into an envelope.
- Parity check: By adding a parity mark the reading code can be checked. The sum of the marks must be even.
- Safety Mark: Is used as an extra security. With skewed paper, the reading head can miss part of the reading code. In these situations, the safety mark is not read, and the system will give an error. The safety mark also indicates the end of the reading code. This mark must always be present on the document if it is part of the code definition.

English

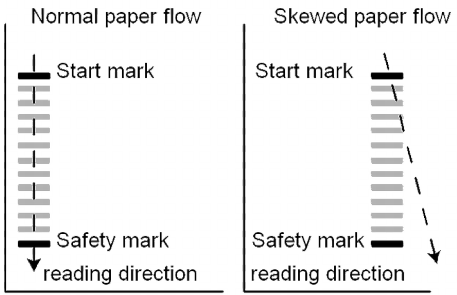

The minimum code is one line: Insert/Accumulate. It is advised for reliability to use the function Start Mark. The function Start Mark is mandatory in case other functions are used.



Default “ no mark printed” means Accumulate and “mark printed” means Insert. If required, the service organization can set the function Insert/Accumulate to: “ no mark printed” means Insert and “mark printed” means accumulate.

## OMR Advanced License

For the OMR advanced license the following functions are available:

- The basic functions from the OMR basic license.
- Divert: The system stops. Remove the set from the collator.
- Stop: The system stops. Remove the set from the collator.
- Selective Feed: If the system reads the function, an enclosure from the enclosure feeder is added to the set.
- Sequence Check: Ensures that no documents are missing from the set; each sheet has a number that is part of the reading code.

## OMR General Remarks

- With OMR, the marks must always be used in the sequence as shown in the figure.

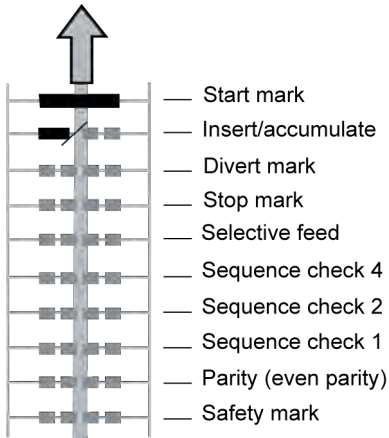

- If a function is suppressed, the following function will move upward by one line.



The mark definition is set by your service organization.

## Adjusting Reading Settings

---

To define the reading settings:

1. From the Settings Menu press **[Reading]**, the reading menu appears.

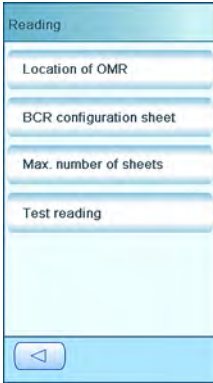

The following functions are available:

- Location of OMR, set the position of the OMR code on a document: not relevant to BCR.
  - BCR configuration sheet: Set BCR configuration code by reading a sheet with a configuration code: not relevant for OMR.
  - Max. Number of Sheets: Define the maximum number of sheets in a document set. Ensure that the number of sheets does not exceed the maximum folding capacity.
  - Test Reading: Test if the reading settings are satisfactory.
-

## Test Reading with OMR

---

Before you start a job with reading, execute a test to ensure that:

- The system finds the reading code on the document.
- The reading code is of sufficient quality.

To test reading:

1. From the Settings Menu, press **[Reading]**.
2. Press the **[Test reading]** button.
3. Select an OMR job. Use your own reading job or use the default test OMR job.
4. Press the **[Test]** button and follow the instructions on screen.

The system tries to locate the OMR marks on the sheet.

If the system indicates 'No OMR read', check the following:

- The system could not find marks on the sheet, because of [bad printing quality](#) on page 37.
  - The system read marks, but it did not match OMR as defined in the system. Contact the service organization for more information on the OMR definition.
- 

## Process Mail Sets with OMR

---

To process mail sets with OMR, select an OMR job or proceed as follows:



The reading settings for OMR / BCR are set in the reading menu. See [Adjusting Reading Settings](#) on page 46.

1. Load the documents and envelopes into the feeders. Place the documents with the OMR codes in the main document feeder, see for more information about the orientation: [OMR Code](#) on page 43.
  2. If necessary, change the fold type. A Z-fold is not possible.
  3. Press Reading  icon and choose Optical Marks (OMR).
  4. Press the Test run **[1x]** icon to create one mail set and follow the instructions on screen.
  5. Press the green **[Start]** button to start the mail set production.
-

# 7 Online Services

## Online Services Introduction (OLS)

---

Online Services (optionally available) enables the document system to connect to a central server. You can use Online Services for:

- Receiving software updates
- Online diagnosis of errors and system problems
- Receiving messages on new options, etc.



It is always the system that initiates the connection. It is not possible to make a connection from outside to the system.

## Connection Settings

---

Before you can connect to a central server, you must set the connection settings. You must set these settings only the first time you use Online Services. You can connect with:

- Local Area Network (LAN)
- Analogue Modem (Optional)

# LAN Configuration for OLS



1. Connect your system to your local area network with a Internet Cable (LAN Cable).
2. From the Settings Menu press [**Supervisor**], and select [**Communication Settings**].
3. Select [**LAN Settings**].

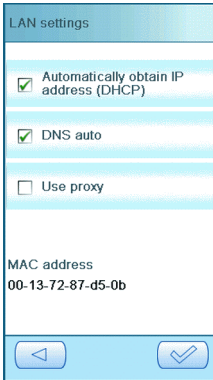

4. Make the settings applicable to your situation and press [**OK**].



You can find detailed information about the OLS settings in the installation guide that is delivered with this product.

5. Select [**LAN Test**] and then select [**Test**] to test the LAN settings.
6. Return to the Communication Settings Menu and then press Forward [**>>**].

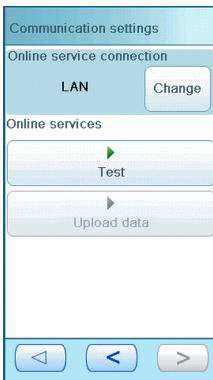

7. Select **[Change]**.
8. Select **[LAN]** and press **[OK]**.
9. Make your connection with the OLS server, [see connecting to the online server](#) on page 51.

---

## Analogue Modem Configuration for OLS

---



1. Ensure the analog modem is connected to the USB port on the system and to an analog phone connection.
2. From the Settings Menu select **[Supervisor]**, **[Communication Settings]**.
3. Press **[Analogue Modem Settings]**.

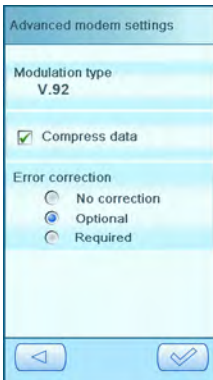

4. Make the settings applicable to your situation and press **[OK]**.



You can find detailed information about the OLS settings in the installation guide that is delivered with this product.

5. Select the **[Analogue Modem Test]** to test the modem settings.
6. Return to the Communication Settings Menu and then press Forward [**>>**].

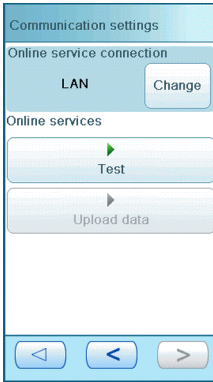

7. Select **[Change]**.
8. Select **[Analogue Modem]** and press **[OK]**.
9. Make your connection with the OLS server, [see connecting to the online server](#) on page 51.

---

## Connecting To The Online Server

---

To connect to the central server:

1. In the Settings Menu press **[Online services]**.

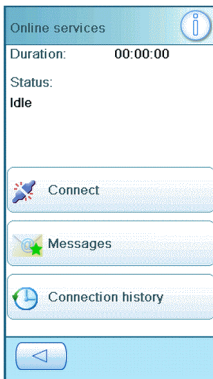



2. Press **[Connect]**.

The system connects to a central server. Wait until the status becomes 'Idle'.

3. Press **[Connection history]** to find out if the connection was successful.

If an error occurs or you are not able to connect, read the error message for more information. If the connection fails, execute the tests in [Test OLS with LAN](#) or [Test OLS with modem](#).

---

## Viewing Connection History

---

The Connection history menu shows previous connections of the system to the server.

To view the connection history:

1. From the Settings Menu select **[Online services]**.
2. Select **[Connection history]**.
3. To view history details, select an event from the list.

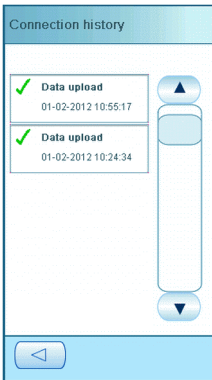

## Viewing Messages

---

The Messages Menu shows the messages received from the server.

To view the messages:



Messages cannot be deleted, when new messages appear, the oldest are removed from the messages list. The list displays up to 30 messages.

1. From the Settings Menu select **[Online services]**.
2. Select **[Messages]**. A check mark indicates that the message is read, a star indicates that the message is not read.

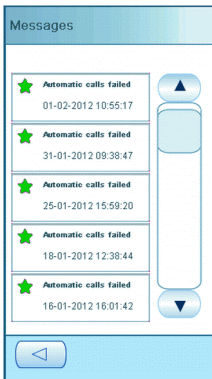

3. To view the contents of a message, select a message from the list and select **[Information]**.

In case the message is about a new job or new software, a button appears. If you press this button you can install the new job or new software.

---

## Downloading and installing jobs and software with OLS

---

The Messages Menu shows the messages received from the server. In case there is new software available download it as follows:

1. From the Settings Menu select **[Online services]**.
2. Select **[Messages]**. A check mark indicates that the message is read, a star indicates that the message is not read.

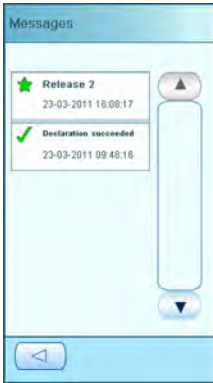

3. To view the contents of a message, select a message from the list. A menu appears that shows more details about the message.
  4. If there is a new job or new software available in the list, a button appears. Press this button to install the new job or new software.
-

# 8 Operator Maintenance

## Maintenance Schedule



Disconnect the mains supply before you do any maintenance to the system. You are not allowed to service the system beyond what is described in this operator manual. All other servicing must be carried out by qualified service personnel only. Please contact your service organization.

- Keep the system in proper condition: remove dust, paper remains, etc.
- When dirty, clean the sealing area and rubber rollers with a slightly wetted cloth, soaked in warm water.

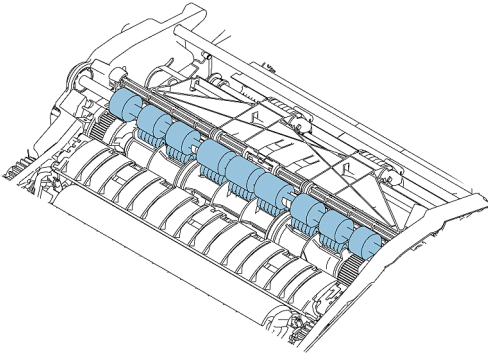

- When dirty or saturated, **clean or replace the brushes of the envelope sealing** on page 56.
- When dirty, clean the feed rollers of the feeders. If necessary **replace the separation rollers** on page 59.
- When dirty, clean the insert rollers.
- Make sure the sealing liquid bottle contains sufficient sealing liquid. If necessary **refill** on page 18.

## Clean or Replace the Brush

---

The brush is used for sealing the envelopes. If the brush is dirty or if you have to replace the brush, proceed as follows:

1. Open the system.
2. Remove the sealing liquid bottle before removing the brush. After removing the sealing liquid bottle close the system again.

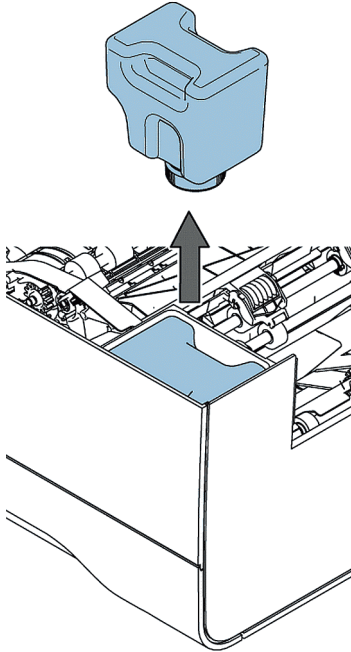

3. From the Settings Menu select **[Supervisor]**, select **[Maintenance]**, select **[Replace brush]**.

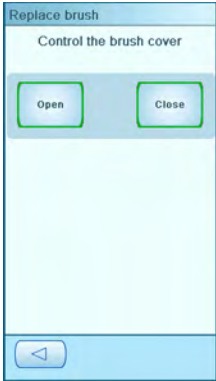

4. Press **[Open]**, the brush cover opens.
5. Open the system.
6. Remove the brush.
- Lift the combiroller A.
  - Lift the pressplate B and keep it in the upright position with your hands.
  - Press the clips on the side of the brush inwards C and lift the brush from the brush holder. Some force needs to be applied.

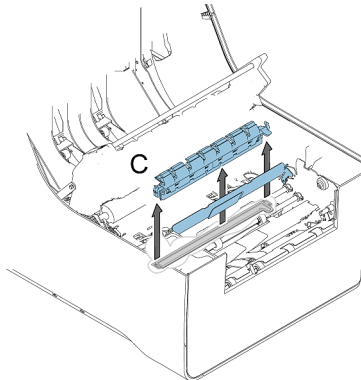
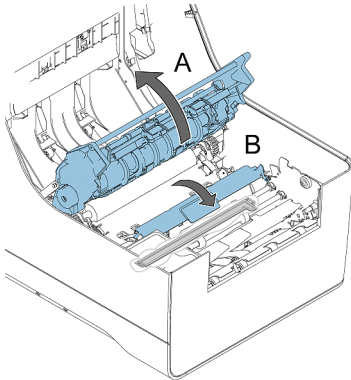

- Clean the brush or moisten the new brush with running tap water.

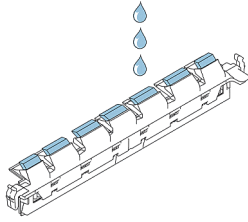

- Replace the brush in the system.

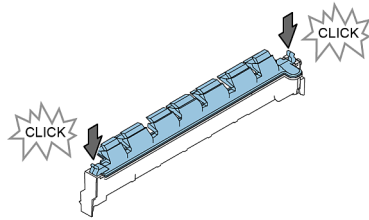

- In the replace brush menu press **[Close]**, the brush cover closes.
  - Place the sealing liquid bottle and close the system.
-

## Replace separation rollers of the document feeder

---

Make sure you have spare parts kit 2828602K available.

To remove the separation rollers from the feeders:

1. Pull the document feeder out of the system.
2. Pull the flap with rollers out of the feeder tray.

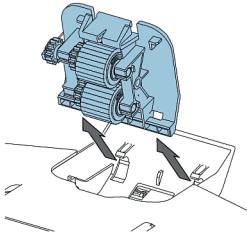
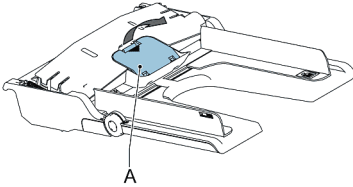



3. Pull the separation axle and roller out of the document feeder tray. Use the special tool (available in the spare parts kit) to pick up the axle.

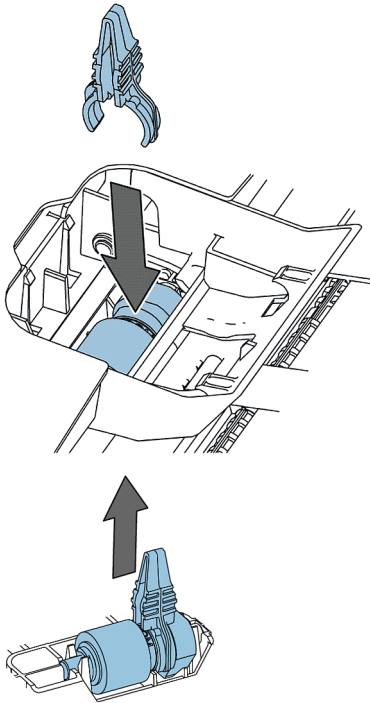

4. Attach the new separation axle to the tool.
5. Install the separation axle in the document feeder. The copper part must fit into the square hole in the feeder bottom. Push the axle until you hear a click.

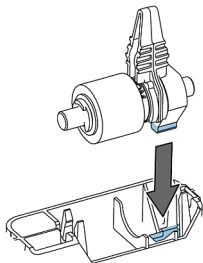

6. Place the new flap with the separation rollers in the feeder.

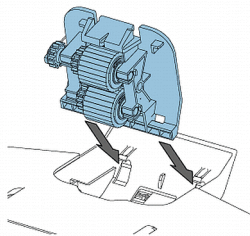

7. Install the document feeder in the system. Push it into the system until you hear a click.
-

# 9 Fault Finding

## Error Messages

When an error occurs the touch screen shows a menu with the following information:

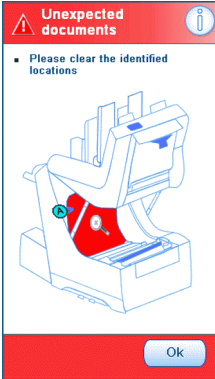

- An indication of the area in which the error occurred
- An error description
- A suggested solution

If the touch screen shows a solution, press the  icon and follow the instructions on screen.

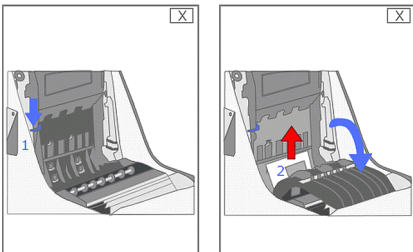

Press the **[i]** button to view detailed information about the error and the possible actions to avoid the error re-occurring.

In case of reading errors (when reading is enabled), the document stops in the collating area. The operator must remove the document set and has to complete the set manually! If you cannot solve the error, read more information in the online help or contact the service organization.

### Warning Screen

When a cover is opened, the touch screen shows a warning screen with the message "Cover open".

## Clearing Stoppages

In case of a stoppage the touch screen shows the location of the stoppage and shows steps how to solve it. If a document or envelope is at an other location, check the following locations:

- Document feeders: pull out the feeder trays
  - BRE feeder: lift the feeder out of the system
  - Inside the system:
1. Open the system.
  2. Make sure that no paper is left at the indicated points.

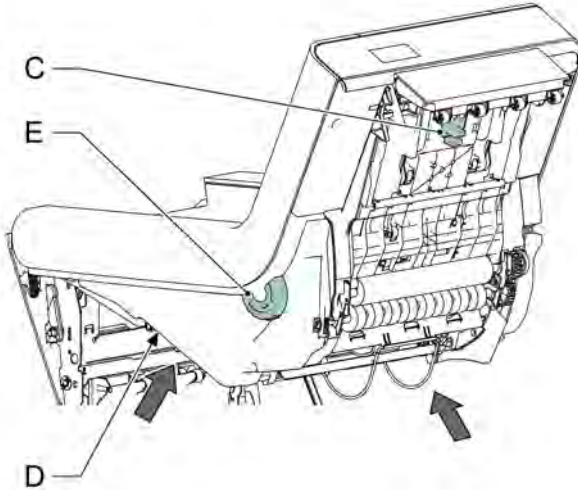

- Squeeze C and open the collator area.

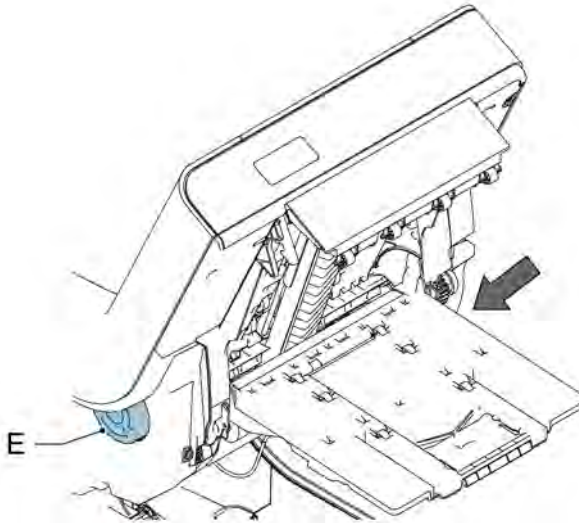

- Rotate E to rotate the collator.
- Open the envelope path: pull lever A and lift part F.

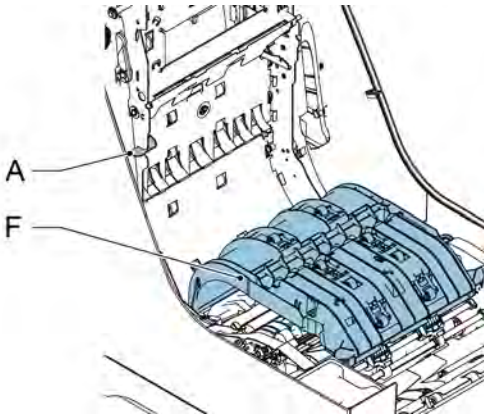

6. Rotate wheel G to move the fold knife.

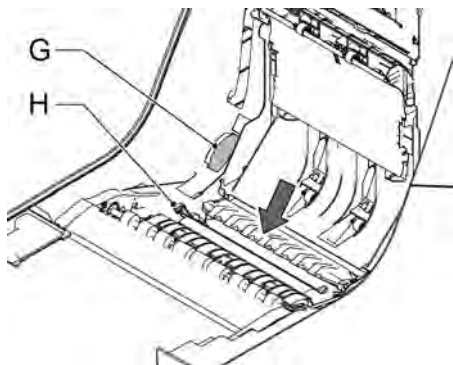

7. Push levers H and lift the folding pocket I out of the system.

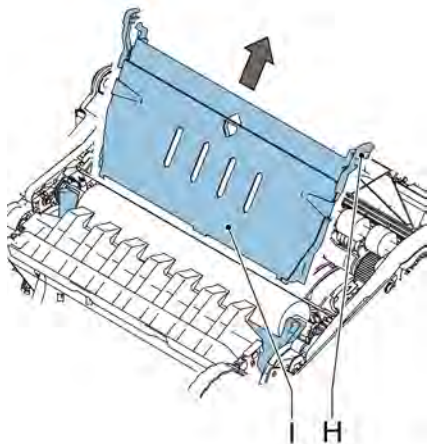

8. Lift B to lift the combi-roller. Rotate J to remove any envelopes.

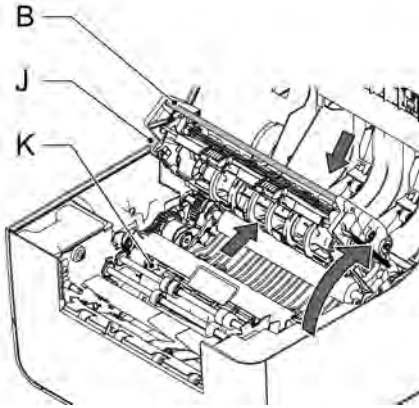

9. Lift moistening brushes K to remove any envelopes.
10. On the front side, push the grips at the bottom of the bottom cover as indicated in the figure and remove the bottom cover from the system.

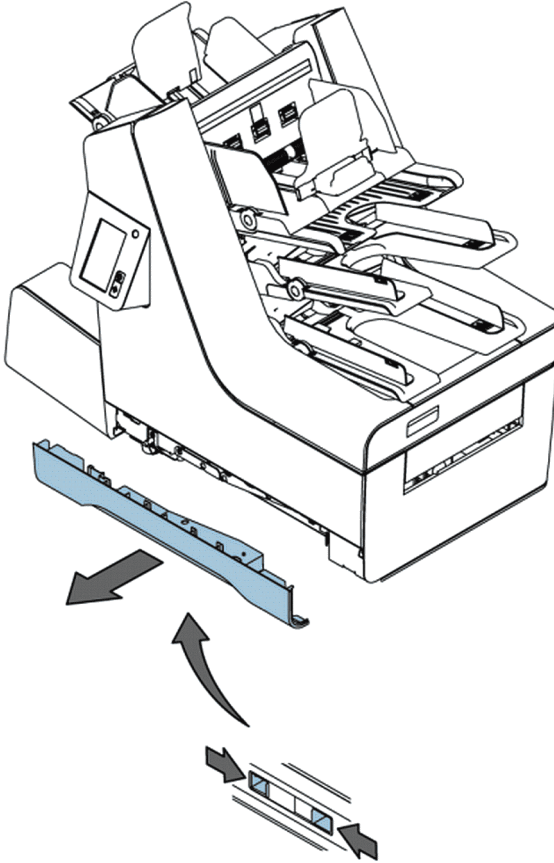

11. Remove any envelopes from the transport belt.
12. When ready, close all covers and close the system.



# Calibrate Sensors

If you get an error on dusty photocells first you have to clean the photocells on the document path or the envelope path. After cleaning the photocells you have to calibrate the sensors.

1. Remove all paper and envelopes from the system.
2. From the Settings Menu select **[Supervisor]**, select **[Maintenance]**, select **[Photocells]**.

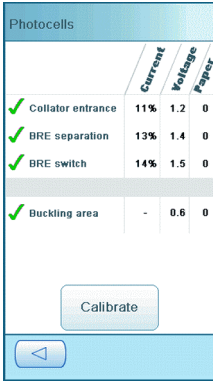

Photocells			
	Current	Voltage	Paper
✔ Collator entrance	11%	1.2	0
✔ BRE separation	13%	1.4	0
✔ BRE switch	14%	1.5	0
✔ Buckling area	-	0.6	0

Calibrate

3. Select **[Calibrate]** to start the calibration of the photocells.

After a short time, a message is displayed that shows the result of the calibration.

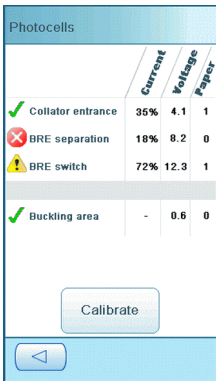

Photocells			
	Current	Voltage	Paper
✔ Collator entrance	35%	4.1	1
✘ BRE separation	18%	8.2	0
⚠ BRE switch	72%	12.3	1
✔ Buckling area	-	0.6	0

Calibrate



This icon means there is still paper at the cell or the cell is broken



This icon means the cell is dusty and must be cleaned.

# Troubleshooting

---

To solve problems:



When you contact the service organization, you will be asked for the last error message.

1. Write down the error number. When you press the [ i ] button in the screen with the error message, an error number is displayed.
  2. Consult the [troubleshooting table to solve the problem](#) on page 69.
  3. Switch the system off and on again to verify system operation.
  4. When the error still occurs contact your service organization.
- 

## Troubleshooting Tables

---

### Startup Problems

Symptom	Possible cause	Remedy	Reference
The system cannot be started.	System not connected to the power supply.	Connect the system to the power supply.	-
	You switched off the system accidentally.	Switch the system on.	-
	A cover is opened.	Close the covers.	-
The display does not start up.	System not connected to the power supply.	Connect the system to the mains the power supply.	-
	You switched off the system accidentally.	Switch the system on.	-

## Envelope Sealing Problems

Symptom	Possible cause	Remedy	Reference
Envelope not closed properly.	Insufficient moistening.		See symptom “Flap not sufficiently moistened” in this table.
	The current job has no envelope sealing.	Make sure sealing is on in the job menu.	<a href="#">Job menu</a> on page 10
	Documents are not correctly inserted.	Make sure the side guides of the document feeders are in the correct position.	<a href="#">Loading documents</a>
Flap not sufficiently moistened.	Water level low.	Check water level, refill if needed.	<a href="#">Filling the sealing liquid bottle</a> on page 18
	Brush dry.	Check brush, replace if necessary by the extra soaked brush.	<a href="#">Replace brush</a> on page 56
	Brush dirty.	Check brush, clean if needed.	<a href="#">Clean brush</a> on page 56
	Brush worn out.	Replace brush.	<a href="#">Replace brush</a> on page 56
	The current job has no envelope sealing.	Make sure sealing is on.	
	Envelope does not meet the specifications.	Use envelopes that meet the specifications.	<a href="#">Envelope specifications</a>
	Poor envelope quality.	Seal an envelope manually to test the adhesion quality.	

## Envelope Feeding Problems

Symptom	Possible cause	Remedy	Reference
Envelopes are double fed.	Envelopes not placed properly in the hopper.	Check and replace if needed.	<a href="#">Loading envelopes on page 16</a>
No envelopes fed.	Hopper is empty.	Refill hopper.	<a href="#">Loading envelopes on page 16</a>
	Side guides set too narrow.	Check side guides and adjust if needed.	<a href="#">Loading envelopes on page 16</a>
Envelope stops skewed.	Side guides of the envelope hopper are set too wide.	Check side guides and adjust if needed.	<a href="#">Loading envelopes on page 16</a>
Envelopes are fed irregularly.	Hopper almost empty.	Refill hopper.	<a href="#">Loading envelopes on page 16</a>
	Side guides set too narrow.	Check side guides and adjust if needed.	<a href="#">Loading envelopes on page 16</a>
Flap is wrinkled and sometimes not opened.	Envelope not within specifications.	Check specifications and change envelopes if needed.	<a href="#">Envelope specifications</a>
	Flap sticks.	Store envelopes according to specifications.	<a href="#">Envelope specifications</a>
	Flap curled.	Envelopes stored or manufactured improperly.	<a href="#">Envelope specifications</a>

## Document Feeding Problems

Symptom	Possible cause	Remedy	Reference
No document fed.	Feeder empty.	Refill feeder.	<a href="#">Loading documents</a>
	Side guides set too narrow.	Adjust the side guides.	<a href="#">Loading documents</a>
	Feeder trays are not installed properly.	Push the tray until it locks.	
Skewed documents fed.	Side guides set too wide.	Adjust the side guides.	<a href="#">Loading documents</a>
Poor or irregularly fed documents.	Side guides set too narrow.	Adjust the side guides.	<a href="#">Loading documents</a>
	Separation rollers are worn out.	Replace separation rollers.	<a href="#">Replace separation rollers of document feeder</a> on page 59
Double documents are fed.	Different types of documents fed.	Use daily mail to process different document types.	<a href="#">Daily Mail</a> on page 23
	Documents out of specification.	Check document specifications.	<a href="#">Document Specifications</a> on page 77

## Insert Problems

Symptom	Possible cause	Remedy	Reference
Envelope leaves system at the back.	Envelopes stacked reversed in the hopper.	Place envelopes correctly in hopper.	<a href="#">Loading envelopes</a> on page 16
	Envelope flap sticks.	Store envelopes according to specifications.	<a href="#">Envelope specifications</a>
	Wrong envelope type used (not according to specifications).	Change envelopes according to specifications.	<a href="#">Envelope specifications</a>
Insert failure.	Envelope throat incorrect.	Check envelope specifications.	<a href="#">Envelope specifications</a>
	Envelope glued inside.	Eliminate faulty envelopes.	-
	Window not glued properly.	Eliminate faulty envelopes.	-
	Document set skewed.	Adjust side guides.	<a href="#">Loading Documents</a>
	Document set to wide.	-	<a href="#">Envelope specifications</a>
	Fingers did not open the envelope.	Choose envelope within specifications.	<a href="#">Envelope specifications</a>
Envelope not always ejected from sealer.	Sealing area dirty.	Clean sealing area.	<a href="#">Maintenance schedule</a> on page 55
Address not readable from window	Address position not correctly defined.	Change address position.	<a href="#">Address position</a> on page 27

## Other Problems

Symptom	Possible cause	Remedy	Reference
Error message 'Dusty sensor'	Sensors are dirty.	Reset the system. If the error persists, calibrate the sensors.	<a href="#">Calibrate sensors</a> on page 68
No power save mode after one hour	The system shows an error message or Online Services is calling		



# 10 Specifications

## Technical Specifications

---

<b>Model</b>	6206 Series
<b>Type</b>	Fold and insert system for medium office use
<b>Theoretical max. speed</b>	2400 inserts per hour, depending on the application
<b>Power consumption - running mode</b>	220-240 VAC / 50 Hz / Maximum 2,5 A / 200 W 100-120 VAC / 60 Hz / Maximum 5 A / 185 W 100 VAC 50 Hz / Maximum 5 A / 200 W 100 VAC 60 Hz / Maximum 5 A / 200 W
<b>Power consumption - standby mode</b>	< 0,5 W
<b>Voltage tolerance</b>	100-240 VAC: -10% / +6% 230 VAC: -10% / +10%
<b>Approvals</b>	EMC Certificate conform EMC-Directive FCC Certificate conform 47CFR, part 15 CB Certificate conform IEC 60950-1 UL Listed I.T.E. (Information Technology Equipment), conform UL-IEC 60950-1, file E153801 Conform NEN-EN-IEC 60950-1 and derivatives
<b>Noise Level</b>	68 dB(A)
<b>Operating temperature</b>	10-40 °C
<b>Humidity</b>	20-65 %

---



## Feeder and Stacker Capacities

---

<b>Document feeders</b>	250 documents of 80 g/m <sup>2</sup> or 60 BRE's of 80 g/m <sup>2</sup>
<b>Daily mail feeder</b>	max. 8 documents of 80 g/m <sup>2</sup>
<b>BRE feeder</b>	250 BRE's of 80 g/m <sup>2</sup> , 250 insert cards of 160 g/m <sup>2</sup> or 1 mm (0.04") thickness
<b>Envelope hopper</b>	250 envelopes of 100 g/m <sup>2</sup>
<b>Stacker</b>	+/- 250 envelopes depending on the set size and fold type

---

## Dimensions

---

<b>Height</b>	685 mm (26.9 ")
<b>Width</b>	445 mm (17.5 ")
<b>Length</b>	800 mm (31.5 ")
<b>Weight</b>	55 kg (121.1 lbs)

---

# Document and Insert Specifications

---

<b>Paper quality</b>	minimum 60 g/m <sup>2</sup> (15 lb bond) maximum 120 g/m <sup>2</sup> (30 lb bond) Booklets up to approximately 1 mm (0.4") thickness
<b>Paper size</b>	Minimum width: 130 mm (5.1") Maximum width: 230 mm (9.1") Minimum length: 90 mm (3.5") Maximum length: 356 mm (14.0")
<b>Paper size daily mail</b>	Fixed width: 216 mm (8.5", Letter size)
<b>Daily mail</b>	Do not place staples in the center of the document, 75 mm (3") to either side of the centre line.
<b>Folding capacity</b>	V-fold - 8 sheets (max. 80 g/m <sup>2</sup> ) C-fold and Z-fold - 5 sheets (max. 80 g/m <sup>2</sup> ) Double V-fold - 2 sheets (max. 80 g/m <sup>2</sup> )
<b>BRE/inserts</b>	Enclosure sizes: standard BRE (Business Reply Envelopes) Maximum length: 158 mm (6.22") or C5, 229 (+/- 10) mm (9") in portrait mode Minimum weight: 75 g/m <sup>2</sup> (18.75 lb bond) Maximum weight: 250 g/m <sup>2</sup> (62.5 lb bond) Maximum weight (from document feeder): 120 g/m <sup>2</sup> (30 lb bond)

---

# Envelope Specifications

10

English

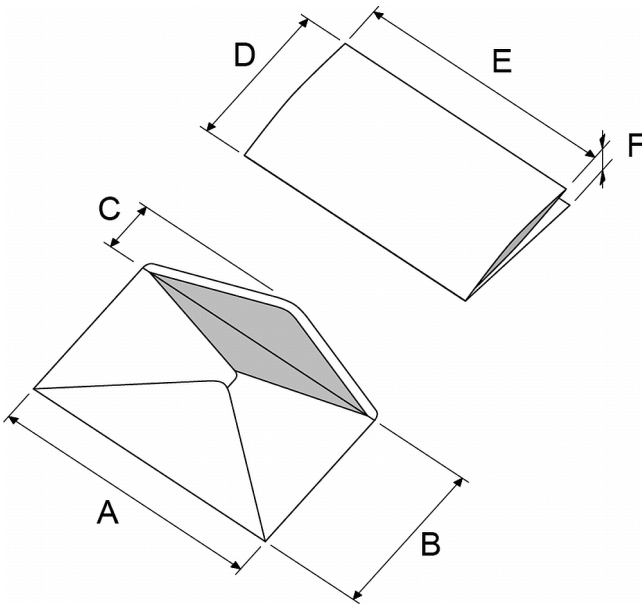

	A common envelope	A small en- velope	B	C	D	E	F
<b>Min. size</b>	220 mm	160 mm	90 mm	32 mm	84 mm	130 mm	60 g/m <sup>2</sup>
<b>Max. size</b>	242 mm	165 mm	162 mm	54 mm*	B - 6 mm	A - 14 mm	2 mm
<b>Min size</b>	8.7"	6.3"	1.3"	1.3"	3.3 "	5.1"	15 lb bond
<b>Max. size</b>	9.5"	6.5"	2.1"	2.1" *	B - 0.02"	A - 0.55"	0.08"

\*The maximum flap height (C) for an envelope with a commercial type flap is 70 mm (2.7")

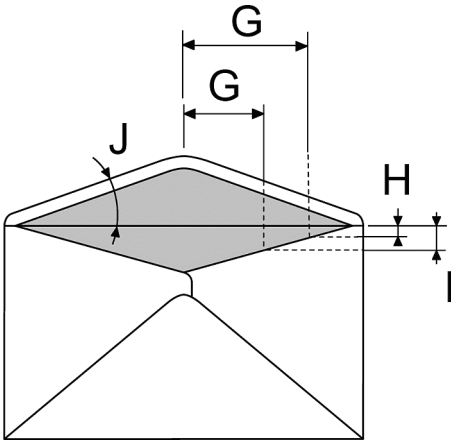

	<b>G</b>	<b>H</b>	<b>I</b>	<b>J</b>
<b>Throat length</b>	68 mm	0 - 26 mm	-	45° - 85°
<b>Throat length</b>	43 mm	-	10 - 36 mm	45° - 85°
<b>Throat length</b>	2.7"	0 - 1.0"	-	45° - 85°
<b>Throat length</b>	1.7"	-	0.4 - 1.4"	45° - 85°

<b>Paper quality</b>	Minimum envelope weight: 75 g/m <sup>2</sup> Maximum envelope weight: 120 g/m <sup>2</sup>
<b>Flap shoulder angle</b>	Between 45° to 85°
<b>Flaptypes</b>	Wallet Mailpoint Trapezoid Commercial Note: Open flap envelopes are not supported
<b>Adhesive type</b>	Gum
<b>Seamtypes</b>	Side seam, Diagonal seam, Single side seam.
<b>Window size</b>	Maximum window width: Envelope width minus 30 mm Maximum window height: 50% of the envelope height Maximum 2 mm of the window is not glued Minimum windows distance to envelopside: 15 mm. Mimimum windows distance to enveloptop: 15 mm to the envelope creaseline
<b>Remarks</b>	Maximum set thickness is 2 mm (0.08")  Maximum insert specifications are based on single sheets. When multiples are handled, more room inside the envelope is needed depending on the application.  In general more space between the set width and the envelope width will improve the performance of the system.  The specification of the paper handling equipment is often wider than that of the envelopes and documents handled.  We recommend that materials to be handled are stored at a teperature of 20°C (68°F) with a relative humidity factor of 50%. If difference in temperature occurs between store room and mailing area, the material has to be stored near the system at least 24 hours before use.